

AIR TOOLS

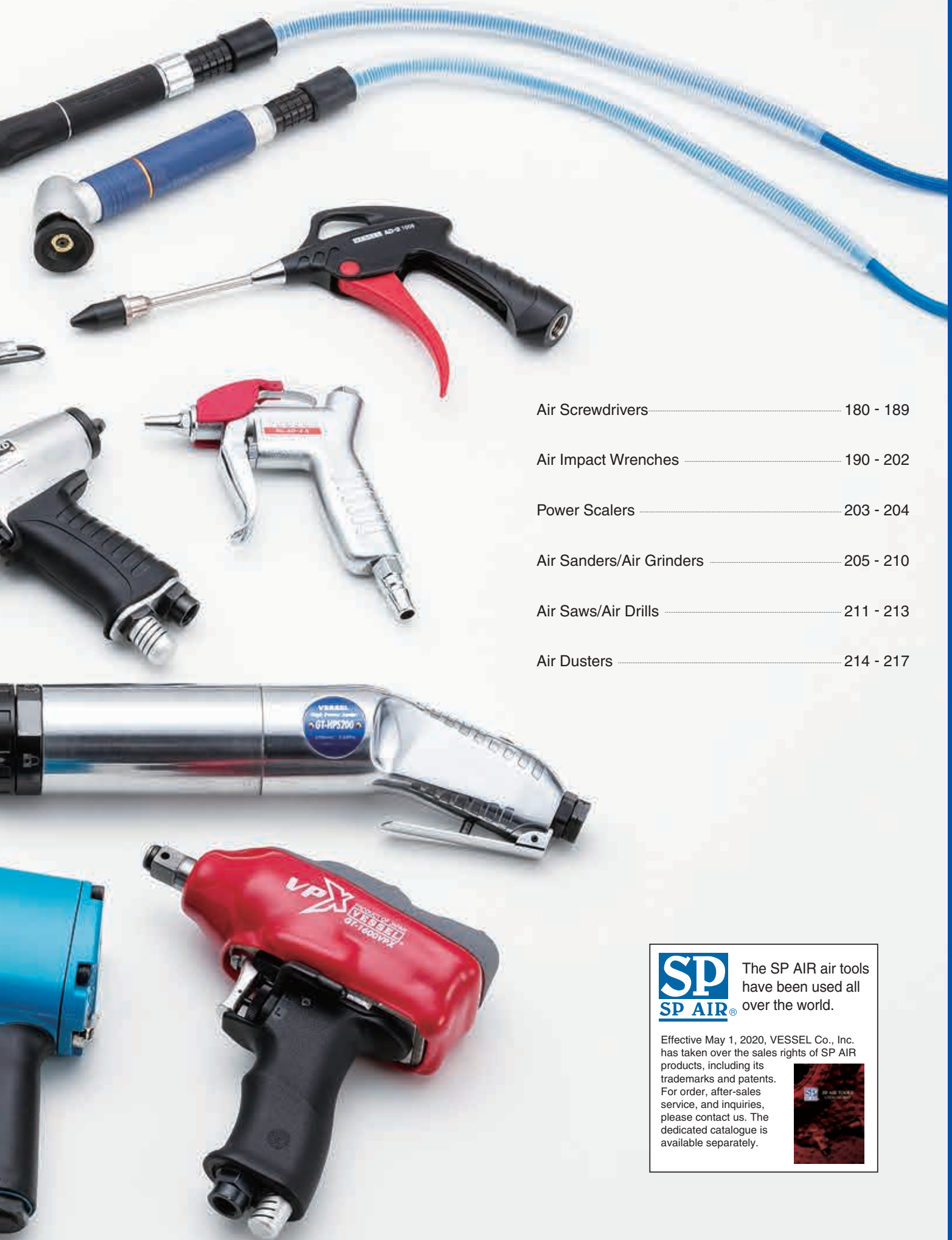



Air Screwdrivers	180 - 189
Air Impact Wrenches	190 - 202
Power Scalers	203 - 204
Air Sanders/Air Grinders	205 - 210
Air Saws/Air Drills	211 - 213
Air Dusters	214 - 217



The SP AIR air tools have been used all over the world.

Effective May 1, 2020, VESSEL Co., Inc. has taken over the sales rights of SP AIR products, including its trademarks and patents. For order, after-sales service, and inquiries, please contact us. The dedicated catalogue is available separately.



AIR TOOLS

RoHS

Environmental Measures

Pb (lead) / Cd (cadmium) / Hg (mercury) / Hexavalent chromium / PBB (polybrominated biphenyl) / PBDE (polybrominated diphenyl ether) / DEHP, BBP, DBP, DIBP (phthalate esters)

The products with this mark in this catalogue are compliant with the RoHS directives (EU) (usage limit of the above 10 substances).

Note: For the updated information on RoHS compliant products, visit our homepage, because some products or sizes are under investigation or are not compliant at the time of publication of this catalogue.



Standard A type Anvil

Can be used with A type of industrial bits.

For more information, contact us.

Option

Can be used with B type of industrial bits.

For more information, contact us.



Pin-lock Type Anvil

Insert socket and lock with a pin.

Mainly used for industrial assembly line.

Tough Aluminum Body

Retainer Ring Type Anvil

Pin-type anvil in combination with a retainer ring. Suitable for work with frequent changes of sockets, as it allows temporary tightening for a while.



Oil Xtra Series (Low noise, Anti-seizing)

The impact mechanism is filled with lubricating oil. In addition to changing the impact noise to a softer and smoother sound, the oil prevents part damage due to friction.

OIL Xtra



Adjust Dial (Dual-purpose switch)

Consolidated control part combining air flow adjustment (output switching) and forward/reverse control switch.



Adjust Dial

Exclusive adjust dial suited for work requiring frequent flow control.

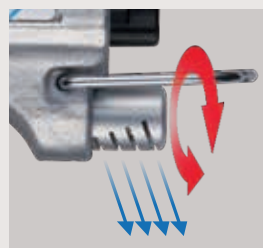

Silencer

Built-in filter reduces exhaust sound.

Adjusting lever to switch the rotation directions

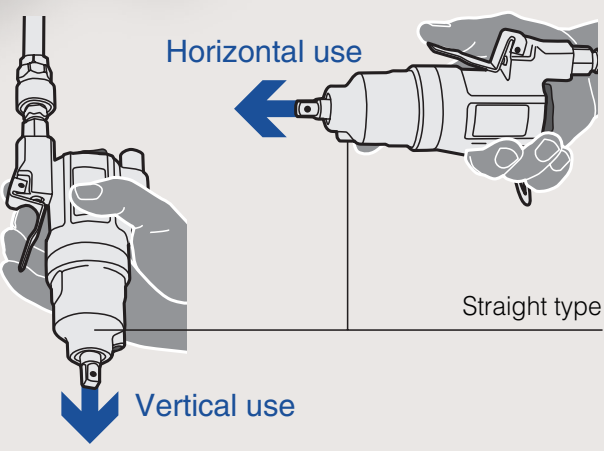
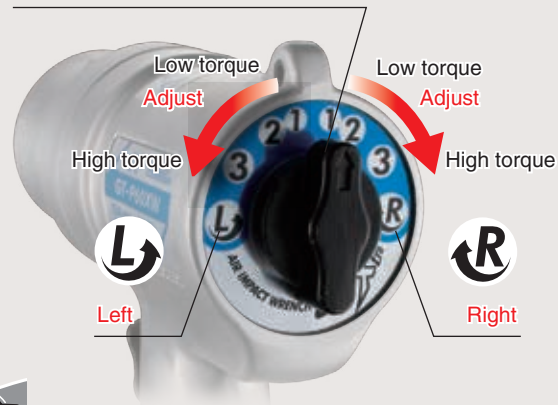

Straight/Pistol type

Various types of grip. Easy-to-hold, stable and well-balanced grip for improved workability.

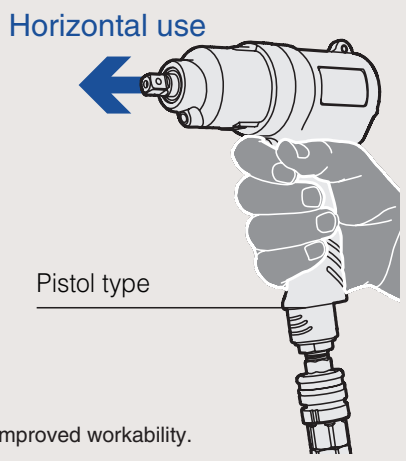

HAND TOOLS

INDUSTRIAL BITS

CONSTRUCTION BITS

RECIPROCATING SAW BLADES

ELECTRIC TOOLS

AIR TOOLS

AIR NIPPERS

STATIC SOLUTIONS

GASOLINE ENGINE TOOLS

GT-P5XD
Air Screwdriver
"Oil Extra" series

Enables high-efficiency work.



In addition to the "Oil Extra" series, of which the lubricating oil circulates in the impact section, we have also developed air tube exhaust system, aiming at the low-noise, low-vibration models.



OIL Xtra

**GT-P5XD
Air Screwdrivers**

The impacting parts are immersed in the lubricating oil. In addition to converting the striking sound into a smooth sound quality, it also prevents parts from seizing due to friction.

Applicable Models ※Only for referential purposes.

Small screw	Philips	Applicable Models
M2	0 (Old JIS 1)	S4TFG, S4TG
M2.3	0 (Old JIS 1)	S4TFG, S4TFS, S4TG, S4TS
M2.5	1	S4TFG, S4TFS, S4TG, S4TS, S5TFG, S5TG
M2.6	0 (Old JIS 1)	H4RC, S4TFS, S4TS, S5TFG, S5TG
M3	1 (Old JIS 2)	H4R, H4RC, S4TFS, S4TS, S4TR, S5TFG, S5TFB, S5TG, S5TB
M3.5	2	H4R, H4RC, H5RC, S4TR, S5TFB, S5TB
M4	2	H4R, H5R, H5P, H5RC, S4.5DR, P4.5DR, PLR, PLP, PLZ, PLRC, P5LS, S4TR, S5TFB, S5TFR, S5TB, S5TR, PLXD, S4.5XD, P4.5XD, PLIXD, P5XD
M4.5	2	H5R, H5P, H5RC, S4.5DR, P4.5DR, PLR, PLP, PLZ, PLRC, P5LS, S5TFR, S5TR, S5TS, PLXD, S4.5XD, P4.5XD, PLIXD, P5XD
M5	2	H5R, H5P, S4.5DR, P4.5DR, PLR, PLP, PLZ, PLRC, P5LS, P6LSⅢ, PLHⅡ, P60XD, S6MLR, S5TFR, S5TR, S5TS, PLXD, S4.5XD, P4.5XD, S6LXD, P6LXD, S60XD, PLIXD, P5XD
M6	3	P6LSⅢ, PLHⅡ, S6MLR, S5TS, S6.5D, P6.5D, S6LXD, P6LXD, P60XD, S60XD
M8	4 (Old JIS 3)	S6.5D, P6.5D, P8D, P60XD, S60XD, P80XD
M10	4	P8D, P80XD

Wood screw	Philips	Applicable Models
1.8	—	H4R
2.1	1	H4R
2.4	1	H4R
2.7	1	H5R, H5P, S4.5DR, P4.5DR, PLR, PLP, PLZ, P5LS, S4.5XD, P4.5XD
3.1	2	H5R, H5P, S4.5DR, P4.5DR, PLR, PLP, PLZ, P5LS, S4.5XD, P4.5XD
3.5	2	H5R, H5P, S4.5DR, P4.5DR, PLR, PLP, PLZ, P5LS, P6LSⅢ, PLHⅡ, S6MLR, PLXD, S4.5XD, P4.5XD, S6LXD, P6LXD, P60XD, S60XD, PLIXD, P5XD
3.8	2	PLHⅡ, P6LSⅢ, S6MLR, S6.5D, P6.5D, PLXD, S6LXD, P6LXD, P60XD, S60XD, PLIXD, P5XD
4.1	2	PLHⅡ, P6LSⅢ, S6MLR, S6.5D, P6.5D, S6LXD, P6LXD, P60XD, S60XD
4.5	2	S6.5D, P6.5D, P60XD, P8D, S60XD, P80XD
4.8	2	P8D, P80XD
5.1	3	P8D, P80XD
5.5	3	P8D, P80XD
5.8	3	P8D, P80XD
6.2	3	P8D, P80XD

Tapping screw	Philips	Applicable Models
3.5	2	H5R, H5P, S4.5DR, P4.5DR, PLR, PLP, PLZ, P5LS, S4.5XD, P4.5XD
4	2	H5R, H5P, S4.5DR, P4.5DR, PLR, PLP, PLZ, P5LS, P6LSⅢ, PLHⅡ, S6MLR, S6.5D, P6.5D, PLXD, PLIXD, P5XD, S4.5XD, P4.5XD, S6LXD, P6LXD, P60XD, S60XD
4.2	2	P6LSⅢ, PLHⅡ, S6MLR, S6.5D, P6.5D, PLXD, PLIXD, P5XD, S6LXD, P6LXD, P60XD, S60XD
4.5	2	P6LSⅢ, PLHⅡ, S6MLR, S6.5D, P6.5D, S6LXD, P6LXD, P60XD, S60XD
4.8	2	P6.5D, P60XD, S60XD
5	2	P6.5D, P8D, P60XD, S60XD, P80XD
5.5	3	P8D, P80XD
6	3	P8D, P80XD

Hexagonal recess bolt Hexagonal head bolt	H (mm)	H (mm)	Applicable Models
M2.5	2.0	5.0	H4RC
M3	2.5	5.5	H4R, H4RC
M3.5	—	6.0	H4R, H4RC, H5RC
M4	3.0	7.0	H4R, H5R, H5P, H5RC, S4.5DR, P4.5DR, PLR, PLP, PLZ, P5LS, PLRC, PLXD, S4.5XD, P4.5XD, PLIXD, P5XD
M5	4.0	8.0	H5R, H5P, S4.5DR, P4.5DR, PLR, PLP, PLZ, P5LS, P6LSⅢ, PLHⅡ, S6MLR, PLRC, PLXD, S4.5XD, P4.5XD, S6LXD, P6LXD, P60XD, S60XD, PLIXD, P5XD
M6	5.0	10.0	P6LSⅢ, PLHⅡ, S6MLR, S6.5D, P6.5D, S6LXD, P6LXD, P60XD, S60XD
M7	—	11.0	S6.5D, P6.5D, P60XD, S60XD
M8	6.0	13.0 (Small bolt 12.0)	S6.5D, P6.5D, P8D, P60XD, S60XD, P80XD
M10	8.0	16.0 (Old JIS 17.0) Small bolt 14.0)	P8D, P80XD

HAND TOOLS

INDUSTRIAL BITS

CONSTRUCTION BITS

RECIPROCATING SAW BLADES

ELECTRIC TOOLS

AIR TOOLS

AIR NIPPERS

STATIC SOLUTIONS

GASOLINE ENGINE TOOLS

Air Screwdrivers Oil Xtra Series

Standard screw 4~5mm Compact, lightweight and high revolution motor. For recycle plant, small sash frame, etc.



← See P178

GT-S4.5XD

6.35 Bit sleeve retainer

- Noise reducer

RoHS



GT-P4.5XD

6.35 Bit sleeve retainer

- Noise reducer/Rear exhaust

RoHS



GT-PLXD

6.35 Bit sleeve retainer

3 Adjust dial

- Noise reducer

RoHS



GT-P5XD

6.35 Bit sleeve retainer

- Noise reducer/Rear exhaust

RoHS



GT-PLIXD

6.35 Bit sleeve retainer

3 Adjust dial

- Noise reducer

RoHS



Reduces noise with air tube

ONE POINT **IGT-PLIXD**

Reduces noise with air tube.

Exhaust noise is reduced by attaching a commercially available $\phi 8\text{mm}$ air tube.

GT-PLIXD
-8dB

※No-load noise
Approx. 78dB

Compared to the existing model
w/ 2m air tube attached.

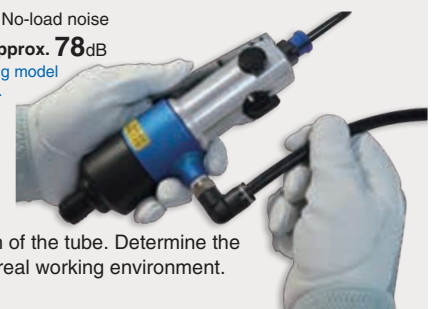

Noise reduction effect, rotating speed, and output torque may vary depending on the length of the tube. Determine the length according to the real working environment.

Code No.	Model No.	Capacity (mm)				No Load Speed (rpm)	Air Consumption (ml/min)	Hose Coupling	Overall Length (mm)	Weight (g)	Accessories		JAN (4907587)
		Standard Screw	Tapping Screw	Wood Screw	Bolt						Bit	Plug	
311085	GT-S4.5XD	4.0~5.0	3.5~4.0	2.7~3.5	4.0~5.0	14,500	0.2	G 1/4	188	585	A14 $\phi 2 \times 65\text{G}$ BPN-2F		301161
311089	GT-P4.5XD	4.0~5.0	3.5~4.0	2.7~3.5	4.0~5.0	14,000	0.2	Rc 1/4	170	735	A14 $\phi 2 \times 65\text{G}$ BPB-2		301406
311113	GT-PLXD	4.0~5.0	3.8~4.2	3.3~3.8	4.0~5.0	11,000	0.35	G 1/4	198.5	670	A14 $\phi 2 \times 65\text{G}$ BPN-2F		301048
311100	GT-P5XD	4.0~5.0	3.5~4.0	3.3~3.8	4.0~5.0	11,000	0.33	Rc 1/4	172	790	A14 $\phi 2 \times 65\text{G}$ BPB-2		301345
311114	GT-PLIXD	4.0~5.0	3.8~4.2	3.3~3.8	4.0~5.0	7,300	0.29	G 1/4	198	740	A14 $\phi 2 \times 65\text{G}$ BPN-2F Tube fitting PL8-02		301024

● Air pressure: 0.6MPa ● Air hose ID: 6.35mm ● Overall length and Weight: Accessories not included.
● Capacity is listed as instant reference and varies depending on operation conditions.

● w/Rotary parts oil (VG-10), Impact parts oil (VG-32)

Anvil for bit mounting
Unless otherwise mentioned, following type is a standard.

Standard type in Japan

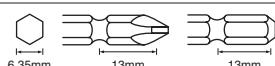

※Option: Anvil for the following size is available.

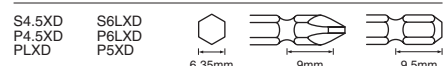

HAND TOOLS

INDUSTRIAL BITS

CONSTRUCTION BITS

RECIPROCATING SAW BLADES

ELECTRIC TOOLS

AIR TOOLS

AIR NIPPERS

STATIC SOLUTIONS

GASOLINE ENGINE TOOLS



←See P178

Standard screw **5~6mm** Stable tightening performance with high power. For sash frame for building, exterior, home building, etc.

GT-S6LXD

6.35 Bit sleeve retainer

3 Adjust dial

● Noise reducer

RoHS



GT-P6LXD

6.35 Bit sleeve retainer

● Noise reducer/Rear exhaust

RoHS



Standard screw **6~8mm** Powerful torque force. For mounting parts, tightening concrete screws, etc.

GT-P60XD

6.35 Bit sleeve retainer

3 Adjust dial

● Noise reducer/Rear exhaust

RoHS



GT-S60XD

6.35 Bit sleeve retainer

3 Adjust dial

● Noise reducer/Rear exhaust

RoHS



Standard screw **8~10mm** Powerful torque force. For mounting parts, tightening concrete screws, etc.

GT-P80XD

8 Bit sleeve retainer

4 Adjust dial

● Noise reducer/Rear exhaust

RoHS



Code No.	Model No.	Capacity (mm)				No Load Speed (rpm)	Air Consumption (l/min)	Hose Coupling	Overall Length (mm)	Weight (g)	Accessories			JAN (4907587)
		Standard Screw	Tapping Screw	Wood Screw	Bolt						Bit	Plug	L-wrench	
311115	GT-S6LXD	5.0~6.0	4.0~4.5	3.6~4.1	5.0~6.0	12,000	0.4	G 1/4	212	815	A14 Φ 2×65G	BPB-2F		301109
311116	GT-P6LXD	5.0~6.0	4.0~4.5	3.6~4.1	5.0~6.0	12,500	0.45	Rc 1/4	184	876	A14 Φ 2×65G	BPB-2		301369
324021	GT-P60XD	6.0~8.0	4.0~5.0	3.8~4.5	6.0~8.0	7,500	0.38	Rc 1/4	176	1,130	A14 Φ 2×65E/ Φ 3×65E	BPB-2	—	301642
324023	GT-S60XD	6.0~8.0	4.0~5.0	3.8~4.5	6.0~8.0	7,500	0.38	Rc 1/4	198	1,030	A14 Φ 2×65E/ Φ 3×65E	BPB-2	—	301147
324050	GT-P80XD	8.0~10.0	5.0~6.0	4.5~6.2	8.0~10.0	7,000	0.4	Rc 1/4	172	1,520	A15 Φ 2×65G/ Φ 3×65E	BPB-2	H4	302236

● Air pressure: 0.6MPa ● Air hose ID: 6.35mm ● Overall length and Weight: Accessories not included.
● Capacity is listed as instant reference and varies depending on operation conditions.

● w/Rotary parts oil (VG-10), Impact parts oil (VG-32)

Anvil for bit mounting
Unless otherwise mentioned, following type is a standard.

Standard type in Japan

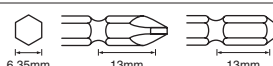

※Option: Anvil for the following size is available.

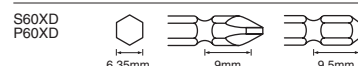

Air Screwdrivers Clutch Type

Standard screw 2.6~3.5mm Speed-reduction type air driver.

GT-H4RC

6.35 Ball spring retainer

● Noise reducer

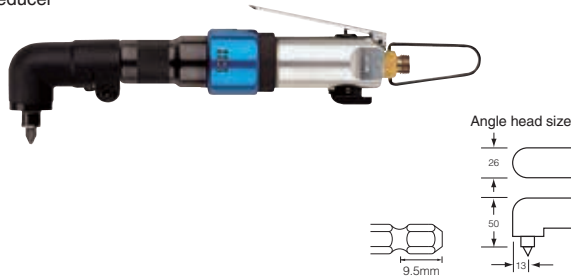

Standard screw 3.5~4.5mm Speed-reduction type air screwdriver.

GT-H5RC

6.35 Ball spring retainer

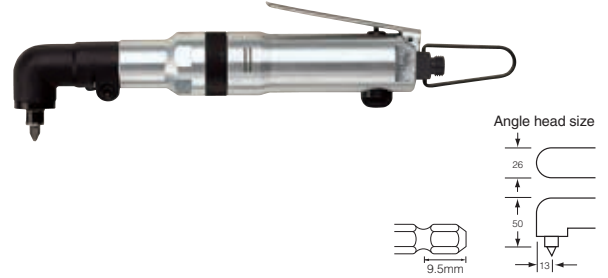

Standard screw 3~4mm Compact, lightweight and silent gear speed-reduction mechanism.

GT-H4R

6.35 Ball spring retainer

● Lever push starting/Noise reducer



Standard screw 4~5mm Stable tightening performance with high power. For mounting electrical parts.

GT-H5R

6.35 Ball spring retainer

● Lever push starting



GT-H5P

6.35 Ball spring retainer

● Push starting/Rear exhaust



ONE POINT

Clutch Type / Gear Type Air Screwdriver

The speed of air motor rotation is reduced by planetary gears so as to raise the rotation torque. As the clutch is built-in, the tightening torque can be modified by adjusting the adjustment nut. Low noise, low vibration, and stable torque output.

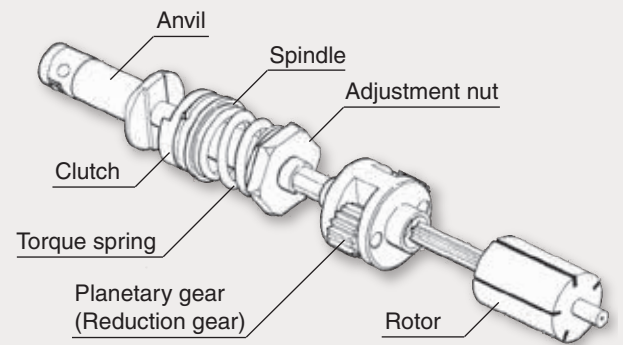

Code No.	Model No.	Capacity (mm)				No Load Speed (rpm)	Air Consumption (m ³ /min)	Hose Coupling	Overall Length (mm)	Weight (g)	Accessories		JAN (4907587)
		Standard Screw	Tapping Screw	Wood Screw	Bolt						Bit	Plug	
311034	GT-H4RC	2.6~3.5	—	—	2.6~3.5	1,500	0.2	G 1/4	229	735	B39 Φ 2×23H	BPN-2F	300416
311064	GT-H5RC	3.5~4.5	—	—	3.5~4.5	1,500	0.25	G 1/4	264	1,047	B39 Φ 2×23H	BPN-2F	300430
311036	GT-H4R	3~4	—	1.8~2.4	3~4	1,500	0.2	G 1/4	190	590	A14 Φ 2×65G	BPN-2F	300218
311066	GT-H5R	4~5	3.5~4	2.7~3.5	4~5	1,500	0.25	G 1/4	225	880	A14 Φ 2×65G	BPN-2F	300270
311065	GT-H5P	4~5	3.5~4	2.7~3.5	4~5	1,500	0.25	G 1/4	235	880	A14 Φ 2×65G	BPN-2F	300294

● Air pressure: 0.6MPa ● Air hose ID: 6.35mm ● Overall length: Accessories and hanger parts not included. ● Weight: Accessories not included.
● Capacity is listed as instant reference and varies depending on operation conditions.

Anvil for bit mounting
Unless otherwise mentioned, following type is a standard.

Standard type in Japan

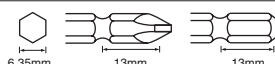

※Option: Anvil for the following size is available.

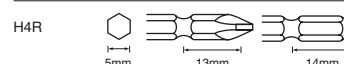

HAND TOOLS

INDUSTRIAL BITS

CONSTRUCTION BITS

RECIPROCATING SAW BLADES

ELECTRIC TOOLS

AIR TOOLS

AIR NIPPERS

STATIC SOLUTIONS

GASOLINE ENGINE TOOLS

Air Screwdrivers Impact Type

Standard screw 4~5mm Compact and lightweight. Basic models for assembly plant.

GT-S4.5DR

- 6.35 Bit sleeve retainer
- Noise reducer

RoHS



GT-P4.5DR

- 6.35 Bit sleeve retainer
- Noise reducer/Rear exhaust

RoHS



GT-PLR

- 6.35 Ball spring retainer
- Adjust dial

RoHS



GT-P5LS

- 6.35 Bit sleeve retainer
- Noise reducer/Rear exhaust

RoHS



GT-PLP

- 6.35 Ball spring retainer
- Push starting/Rear exhaust

RoHS



GT-PLZ

- 6.35 Bit sleeve retainer
- Adjust dial
- Noise reducer

RoHS



Code No.	Model No.	Capacity (mm)				No Load Speed (rpm)	Air Consumption (ml/min)	Hose Coupling	Overall Length (mm)	Weight (g)	Accessories		JAN (4907587)
		Standard Screw	Tapping Screw	Wood Screw	Bolt						Bit	Plug	
311084	GT-S4.5DR	4.0~5.0	3.5~4.0	2.7~3.5	4.0~5.0	14,000	0.2	G 1/4	180	585	A14 Φ 2×65G BPN-2F		301185
311088	GT-P4.5DR	4.0~5.0	3.5~4.0	2.7~3.5	4.0~5.0	14,000	0.2	Rc 1/4	164	715	A14 Φ 2×65G BPB-2		301420
311096	GT-PLR	4.0~5.0	3.5~4.0	2.7~3.5	4.0~5.0	9,000	0.2	G 1/4	187	830	A14 Φ 2×65G BPN-2F		301031
311099	GT-P5LS	4.0~5.0	3.5~4.0	2.7~3.5	4.0~5.0	9,000	0.2	Rc 1/4	165	980	A14 Φ 2×65G BPB-2	Air regulator	301338
311095	GT-PLP	4.0~5.0	3.5~4.0	2.7~3.5	4.0~5.0	9,000	0.2	G 1/4	197	750	A14 Φ 2×65G BPN-2F		301055
311111	GT-PLZ	4.0~5.0	3.5~4.0	2.7~3.5	4.0~5.0	9,000	0.2	G 1/4	205	950	A14 Φ 2×65G BPN-2F		301079

● Air pressure: 0.6MPa ● Air hose ID: 6.35mm ● Overall length: Accessories and hanger parts not included. ● Weight: Accessories not included.
 ● Capacity is listed as instant reference and varies depending on operation conditions.

Anvil for bit mounting
 Unless otherwise mentioned, following type is a standard.

Standard type in Japan

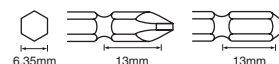

※Option: Anvil for the following size is available.

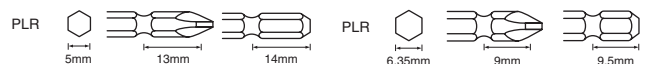

HAND TOOLS

INDUSTRIAL BITS

CONSTRUCTION BITS

RECIPROCATING SAW BLADES

ELECTRIC TOOLS

AIR TOOLS

AIR NIPPERS

STATIC SOLUTIONS

GASOLINE ENGINE TOOLS

Air Screwdrivers Impact Type

Standard screw 4~5mm Angle impact screwdriver.

GT-PLRC

6.35 Ball spring retainer

3 Adjust dial

RoHS

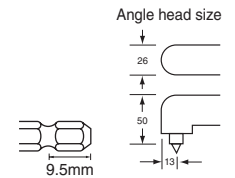

Standard screw 5~6mm Compact and lightweight. Basic models for assembly plant.

GT-PLHII

6.35 Bit sleeve retainer (Pull type)

3 Adjust dial

OP Anvil (Bit sleeve retainer, push type)

RoHS



GT-P6LSIII

6.35 Bit sleeve retainer (Pull type)

Noise reducer/Rear exhaust

OP

Anvil (Bit sleeve retainer, push type)

Rubber grip

RoHS



Rubber grip type available as option.

GT-S6MLR

6.35 Bit sleeve retainer (Pull type)

3 Adjust dial

RoHS



Code No.	Model No.	Capacity (mm)				No Load Speed (rpm)	Air Consumption (m ³ /min)	Hose Coupling	Overall Length (mm)	Weight (g)	Accessories		JAN (4907587)
		Standard Screw	Tapping Screw	Wood Screw	Bolt						Bit	Plug	
311112	GT-PLRC	4.0~5.0	—	—	4.0~5.0	9,000	0.2	G 1/4	230	1,100	B39 Φ2×23H	BPN-2F	301819
311094	GT-PLHII	5.0~6.0	4.0~4.5	3.6~4.1	5.0~6.0	8,500	0.3	Rc 1/4	213	925	A14 Φ2×65G	BPB-2	301093
311098	GT-P6LSIII	5.0~6.0	4.0~4.5	3.6~4.1	5.0~6.0	9,000	0.3	Rc 1/4	177	955	A14 Φ2×65G	BPB-2	301352
311106	GT-S6MLR	5.0~6.0	4.0~4.5	3.6~4.1	5.0~6.0	8,500	0.25	G 1/4	215	1,120	A14 Φ2×65G	BPN-2F	301116

● Air pressure: 0.6MPa ● Air hose ID: 6.35mm ● Overall length: Accessories and hanger parts not included. ● Weight: Accessories not included.
● Capacity is listed as instant reference and varies depending on operation conditions.

Anvil for bit mounting
Unless otherwise mentioned, following type is a standard.

Standard type in Japan

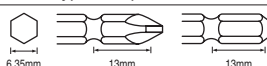

※Option: Anvil for the following size is available.

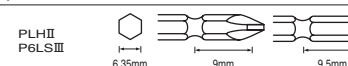

HAND TOOLS

INDUSTRIAL BITS

CONSTRUCTION BITS

RECIPROCATING SAW BLADES

ELECTRIC TOOLS

AIR TOOLS

AIR NIPPERS

STATIC SOLUTIONS

GASOLINE ENGINE TOOLS

Standard screw 6~8mm Powerful torque force. Excellent durability.

GT-S6.5D

- 6.35 Bit sleeve retainer
- 4 Adjust dial
- RoHS



GT-P6.5D

- 6.35 Bit sleeve retainer
- 3 Adjust dial
- RoHS



Standard screw 8~10mm High power models. For mounting various parts.

GT-P8D

- 8 Bit sleeve retainer
- 3 Adjust dial
- RoHS



ONE POINT

Impact Type Air Screwdriver

The rotation of the air motor is transmitted to the hammer, which generates powerful torque by its striking force on the anvil. The "two strikes per revolution" structure features smooth and speedy tightening force. Designed for production lines that give importance to screw tightening efficiency.

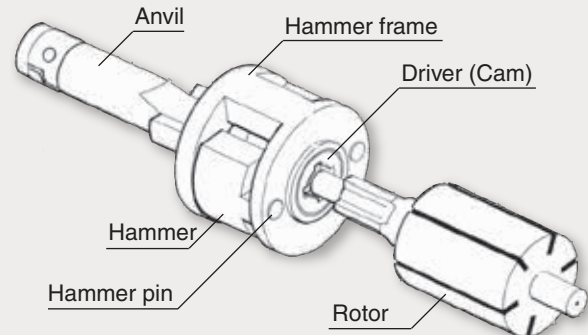

Code No.	Model No.	Capacity (mm)				No Load Speed (rpm)	Air Consumption (ml/min)	Hose Coupling	Overall Length (mm)	Weight (g)	Accessories			JAN (4907587)
		Standard Screw	Tapping Screw	Wood Screw	Bolt						Bit	Plug	L-wrench	
324040	GT-S6.5D	6.0~8.0	4.0~4.5	3.8~4.5	6.0~8.0	7,500	0.35	Rc 1/4	217	1,300	A14 Φ 2×65E/ Φ 3×65E	BPB-2	H4	304025
324041	GT-P6.5D	6.0~8.0	4.0~5.0	3.8~4.5	6.0~8.0	8,500	0.38	Rc 1/4	152	1,450	A14 Φ 2×65E/ Φ 3×65E	BPB-2	H4	304032
324046	GT-P8D	8.0~10.0	5.0~6.0	4.5~6.2	8.0~10.0	7,500	0.4	Rc 1/4	172	1,930	A15 Φ 2×65G/ Φ 3×65E	BPB-2	H4	301673

• Air pressure: 0.6MPa • Air hose ID: 6.35mm • Overall length and Weight: Accessories and hanger parts not included.
 • Capacity is listed as instant reference and varies depending on operation conditions.

Anvil for bit mounting
 Unless otherwise mentioned, following type is a standard.

Standard type in Japan

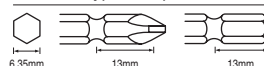

Torque Control Air Screwdriver, Gear Type

HAND TOOLS

INDUSTRIAL BITS

CONSTRUCTION BITS

RECIPROCATING SAW BLADES

ELECTRIC TOOLS

AIR TOOLS

AIR NIPPERS

STATIC SOLUTIONS

GASOLINE ENGINE TOOLS

Standard screw 2~2.5mm Air is automatically shut out when torque reaches a set value.

GT-S4TFG

- 5 Ball spring retainer
- Push startup type/Noise reducer/Rear exhaust
- OP Torque Spring

RoHS

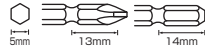

GT-S4TG

- 6.35 Ball spring retainer
- Adjust dial type
- Push startup type/Noise reducer/Rear exhaust
- OP Torque Spring Hose Coupling (1/8")

RoHS



Standard screw 2.2~3mm Air is automatically shut out when torque reaches a set value.

GT-S4TFS

- 5 Ball spring retainer
- Push startup type/Noise reducer/Rear exhaust
- OP Torque Spring

RoHS

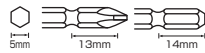

GT-S4TS

- 6.35 Ball spring retainer
- Adjust dial type
- Push startup type/Noise reducer/Rear exhaust
- OP Torque Spring Hose Coupling (1/8")

RoHS



Standard screw 3~4mm Air is automatically shut out when torque reaches a set value.

GT-S4TR

- 6.35 Ball spring retainer
- Adjust dial type
- Push startup type/Noise reducer/Rear exhaust
- OP Torque Spring Hose Coupling (1/8")

RoHS



Code No.	Model No.	Capacity Standard Screw (mm)	Torque Range (N·m)	No Load Speed (rpm)	Air Consumption (ml/min)	Hose Coupling	Overall Length (mm)	Weight (g)	Accessories		JAN (4907587)
									Bit	Plug	
311206	GT-S4TFG	2.0~2.5	0.3~0.8	2,300	0.28	Rc 1/8	215	565	B36 ⊕2×70H	—	305176
311203	GT-S4TG	2.0~2.5	0.3~0.8	2,300	0.28	Rc 1/4	215	650	A14 ⊕2×65G	BPB-2	305084
311205	GT-S4TFS	2.2~3.0	0.5~1.3	1,700	0.28	Rc 1/8	215	555	B36 ⊕2×70H	—	305169
311202	GT-S4TS	2.2~3.0	0.5~1.3	1,700	0.28	Rc 1/4	215	640	A14 ⊕2×65G	BPB-2	305077
311201	GT-S4TR	3.0~4.0	0.7~2.1	1,100	0.28	Rc 1/4	215	650	A14 ⊕2×65G	BPB-2	305060

● Air pressure: 0.6MPa ● Air hose ID: 6.35mm ● Overall length: Accessories and hanger parts not included. ● Weight: Accessories not included.
● Capacity is listed as instant reference and varies depending on operation conditions.

ONE POINT

Torque Spring Change

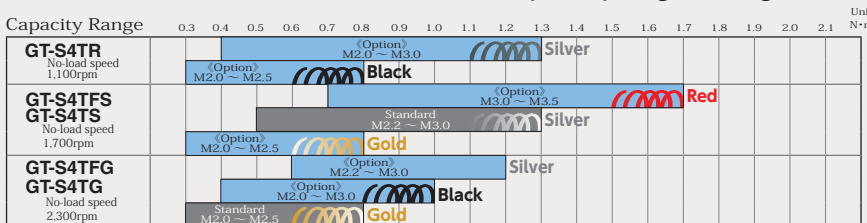

The GT-S4T/S5T series enable easily to adjust the torque range just by replacing with the optional torque spring. When adjusting, choose a torque spring so that the tightening torque value is around the midst of the torque range.

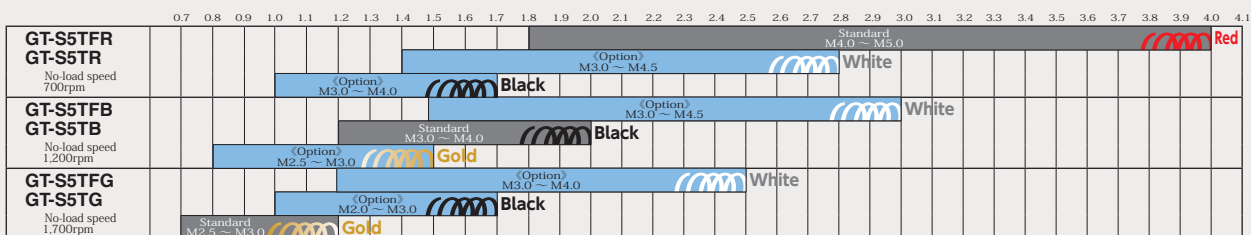

Standard screw 2.5~3mm Air is automatically shut out when torque reaches a set value.

GT-S5TFG

- 5 Ball spring retainer
- Push startup type/Noise reducer/Rear exhaust

OP Torque Spring

RoHS

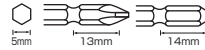

GT-S5TG

- 6.35 Ball spring retainer
- Adjust dial type
- Push startup type/Noise reducer/Rear exhaust

OP Torque Spring

RoHS



Standard screw 3~4mm Air is automatically shut out when torque reaches a set value.

GT-S5TFB

- 5 Ball spring retainer
- Push startup type/Noise reducer/Rear exhaust

OP Torque Spring

RoHS

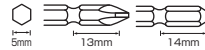

GT-S5TB

- 6.35 Ball spring retainer
- Adjust dial type
- Push startup type/Noise reducer/Rear exhaust

OP Torque Spring

RoHS



Standard screw 4~5mm Air is automatically shut out when torque reaches a set value.

GT-S5TFR

- 5 Ball spring retainer
- Push startup type/Noise reducer/Rear exhaust

OP Torque Spring

RoHS

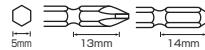

GT-S5TR

- 6.35 Ball spring retainer
- Adjust dial type
- Push startup type/Noise reducer/Rear exhaust

OP Torque Spring

RoHS



Torque Control Air Screwdriver, Impact Type

Standard screw 4.5~6mm Combination of tightening with impact and torque control type produces excellent workability.

GT-S5TS

- 6.35 Bit sleeve retainer (Pull type)
- Adjust dial type



Code No.	Model No.	Capacity Standard Screw (mm)	Torque Range (N·m)	No Load Speed (rpm)	Air Consumption (ml/min)	Hose Coupling	Overall Length (mm)	Weight (g)	Accessories			JAN (4907587)
									Bit	Plug	L-wrench	
311215	GT-S5TFG	2.5~3.0	0.7~1.2	1,700	0.35	Rc 1/8	243	860	B36 Φ 2×70H	—	—	305237
311212	GT-S5TG	2.5~3.0	0.7~1.2	1,700	0.35	Rc 1/4	260	920	A14 Φ 2×65G	BPB-2	—	305206
311214	GT-S5TFB	3.0~4.0	1.2~2.0	1,200	0.35	Rc 1/8	243	830	B36 Φ 2×70H	—	—	305220
311211	GT-S5TB	3.0~4.0	1.2~2.0	1,200	0.35	Rc 1/4	260	910	A14 Φ 2×65G	BPB-2	—	305190
311213	GT-S5TFR	4.0~5.0	1.8~4.0	700	0.35	Rc 1/8	243	850	B36 Φ 2×70H	—	—	305213
311210	GT-S5TR	4.0~5.0	1.8~4.0	700	0.35	Rc 1/4	260	930	A14 Φ 2×65G	BPB-2	—	305183
324002	GT-S5TS	4.5~6.0	3.9~9.8	6,500	0.25	Rc 1/4	292	1,310	A14 Φ 2×65G	BPB-2	H3	305053

• Air pressure: 0.6MPa • Air hose ID: 6.35mm • Overall length: Accessories and hanger parts not included. • Weight: Accessories not included. • Capacity is listed as instant reference and varies depending on operation conditions.

Anvil for bit mounting

Unless otherwise mentioned, following type is a standard.

Standard type in Japan

※Option: Anvil for the following size is available.

HAND TOOLS

INDUSTRIAL BITS

CONSTRUCTION BITS

RECIPROCATING SAW BLADES

ELECTRIC TOOLS

AIR TOOLS

AIR NIPPERS

STATIC SOLUTIONS

GASOLINE ENGINE TOOLS

GT-1600VPH

Air Impact Wrenches

Oilless Super Light V-Hammer

Environmental-friendly Oilless structure



Cylinder

Anodized layer (lubricated)
+ Fluororesin coating

Bearing

Stainless bearing

Rotor

Plating layer (lubricated)
+ Fluororesin coating

Rotor blade

Epoxide-based resin (lubricated)
Smooth rotation even without oiling.

Valve

Nickel plating finish
(anti-corrosion, lubricated)

w/ Inlet mesh

Stainless mesh

**GT-1600VPH
Air Impact Wrench**

Completely oilless design with the air passage which is anti-corrosive and lubricated.

No oil mist is generated, resulting in an environmentally friendly, maintenance-free impact wrench.

※Image is for illustration purposes.

Air Impact Wrenches Model Selection Chart

※Fastening torque is based on JIS B1083. (Metric coarse screw, friction coefficient μ : 0.15) The following selection chart is for referential purposes only.

JISB1051 Strength Category

Screw diameter	3.6		4.6		4.8		5.6		5.8		6.8		8.8		10.9		12.9	
	Torque (N · m)	Applicable Models	Torque (N · m)	Applicable Models	Torque (N · m)	Applicable Models	Torque (N · m)	Applicable Models	Torque (N · m)	Applicable Models	Torque (N · m)	Applicable Models	Torque (N · m)	Applicable Models	Torque (N · m)	Applicable Models	Torque (N · m)	Applicable Models
M8	8.7	800	11.0	800	15.6	800	13.7	800 1000	19.2	800 1000	22.0	800 1000	29.3	1000	43.0	1000 1400	50.4	1000 1400
M10	17.1	800 1000	21.6	1000	30.6	1000	27.0	1000	37.8	1000 1400	43.2	1000 1400	57.6	1000 1400	84.7	1000 1400	99.1	1400 1600
M12	29.4	1000 1400	37.2	1000 1400	52.7	1400 1600	46.5	1400 1600	65.1	1400 1600	74.4	1400 1600	99.1	1400 1600	145.6	1600 2000	170.4	1600 2000
M14	46.9	1400	59.3	1400 1600	84.0	1600 2000	74.1	1400 1600	103.8	1400 1600	118.6	1600	158.1	1600 2000	232.2	2000	271.7	2000
M16	73.0	1600	92.2	1600	130.6	1600 2000	115.3	1600 2000	161.4	1600 2000	184.4	1600 2000	245.9	2000 2500	361.2	2000 2500	422.7	2000 2500
M18	100.8	1600 2000	127.3	1600 2000	180.4	2000	159.2	2000	222.8	2000	254.7	2000 2500	350.2	2000 2500	498.8	2500	583.6	2500
M20	142.7	2000	180.3	2000	255.4	2000	225.4	2000	315.5	2000 2500	360.6	2000 2500	495.9	2500	706.2	2500	826.4	2500 3800
M22	196.6	2000	284.4	2500	351.9	2500	310.5	2500	434.7	2500	496.7	2500 3800	683.0	2500 3800	972.8	3800	1138.4	3800 4200 4800
M24	245.9	3800	310.7	3800	440.1	3800	388.3	3800	543.7	3800	621.3	3800	854.3	3800	1216.8	3800 4200 4800	1423.9	3800 4200 4800
M27	365.0	3800	461.0	3800	653.1	3800	576.2	3800	806.7	3800	922.0	3800	1267.7	3800 4200	1805.6	S55R	2112.9	S55R
M30	494.6	3800	624.8	3800	885.2	3800	781.0	3800	1093.4	3800 4200 4800	1249.6	3800 4200 4800	1718.2	4200 4800 S55R	2447.2	S55R	2863.7	
M33	666.7	3800	842.1	3800	1193.0	3800	1052.6	3800	1473.7	4200 4800	1684.2	S55R	2315.8	S55R	3298.2		3859.6	
M36	862.5	3800	1089.5	4200 4800	1543.4	4200 4800 S55R	1767.8	4200 4800	1906.6	S55R	2178.9	S55R	2996.0		4267.1		4993.4	
M39	1119.6	4200 4800	1414.2	4200 4800	2003.5	S55R	1767.8	S55R	2474.9		2828.5		3889.2		5539.1		6482.0	
M42	1385.0	4200 4800	1749.4	S55R	2478.3	S55R	2186.8	S55R	3061.5		3498.8		4810.9		6851.9		8018.2	
M45	1733.0	S55R	2189.0	S55R	3101.1		2736.3		3830.8		4378.0		6019.8		8573.6		10033.0	
M48	2092.1	S55R	2642.6		3743.7		3303.3		4624.6		5285.3		7267.3		10350.3		12112.1	
M52	2692.9	S55R	3401.6		4818.9		4252.0		5953.8		6803.2		9354.4		13322.9		15590.6	

800 : GT-P6II / S650 / S65W / P65W / S70WK / P60XW / S60XW

1000 : GT-P8II / P80W / P80XW / C900

1400 : GT-1400P / P12 / C1400

1600 : GT-1600VPX / 1600VP(L) / 1600VP(L) / P14J (L) / 1600P / P14W

2000 : GT-2000PF / P18J(L) / 2000P / S20RW

2500 : GT-2500LF / 2500PF / S220W

3800 : GT-3900VL / 3900VP / 3900V / 3800LX / S32RW

4200 : GT-4200PF / 4200P / 4200

4800 : GT-4800VL

S55R : GT-S55R

HAND TOOLS

INDUSTRIAL BITS

CONSTRUCTION BITS

RECIPROCATING SAW BLADES

ELECTRIC TOOLS

AIR TOOLS

AIR NIPPERS

STATIC SOLUTIONS

GASOLINE ENGINE TOOLS

Air Impact Wrenches Super Light V-Hammer

● Ordinary Bolt Dia. **16mm** Compact, lightweight and high power with V shape hammer system.

GT-1600VPX

- 12.7 Retainer ring
- 4 Adjust dial
- Rear exhaust



GT-1600VP

- 12.7 Retainer ring
- 4 Adjust dial
- Rear exhaust
- RoHS



GT-1600VPL

- 12.7 Retainer ring
- 4 Adjust dial
- Rear exhaust
- RoHS



GT-1600VPH

- 12.7 Retainer ring
- 4 Adjust dial
- Rear exhaust



Oil-less type
← See P190

GT-1600VPHL

- 12.7 Retainer ring
- 4 Adjust dial
- Rear exhaust



Oil-less type
← See P190

ONE POINT

Ultra Compact Hammer

The powerful tightening force is generated while the hammer moves as it rotates and strikes the anvil.
Feature: the tool can be compact and lightweight because there is very little striking loss.

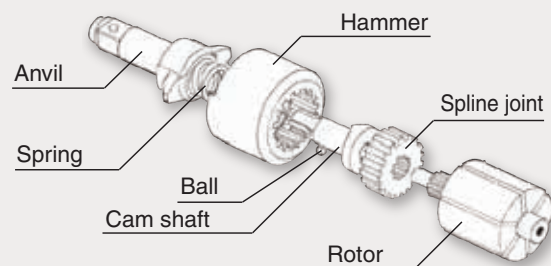

Code No.	Model No.	Capacity Ordinary Bolt Dia. (mm)	Torque Range (N·m)	Max. Torque (N·m)	No Load Speed (rpm)	Air Consumption (m ³ /min)	Hose Coupling	Air Hose Inner Dia. (mm)	Overall Length (mm)	Weight (kg)	Accessories		JAN (4907587)
											Plug	L-wrench	
336013	GT-1600VPX	16	49~294.2	360.0	8,200	0.4	Rc 1/4	6.35	169	1.48	BPB-2	H4	304841
336010	GT-1600VP	16	49~304.0	366.7	8,500	0.4	Rc 1/4	6.35	171	1.91	BPB-2	H4	304810
336016	GT-1600VPL	16	49~304.0	366.7	8,500	0.4	Rc 1/4	6.35	199	1.95	BPB-2	H4	304858
336012	GT-1600VPH	16	49~284.3	352.0	8,200	0.4	Rc 1/4	6.35	174.5	1.75	BPB-2	H4	304896
336017	GT-1600VPHL	16	49~284.3	352.0	8,200	0.4	Rc 1/4	6.35	202.5	1.8	BPB-2	H4	304902

● Air pressure: 0.6MPa ● Overall length and Weight: Accessories not included. ● Capacity is listed as instant reference and varies depending on operation conditions.

HAND TOOLS
INDUSTRIAL BITS
CONSTRUCTION BITS
RECIPROCATING SAW BLADES
ELECTRIC TOOLS
AIR TOOLS
AIR NIPPERS
STATIC SOLUTIONS
GASOLINE ENGINE TOOLS

Ordinary Bolt Dia. **39mm** Compact, lightweight and high power with V shape hammer system.

GT-3900VP

- 25.4 Retainer ring
- ④ Adjust dial
- Rear exhaust



GT-3900VL

- 25.4 Retainer ring
- ④ Adjust dial

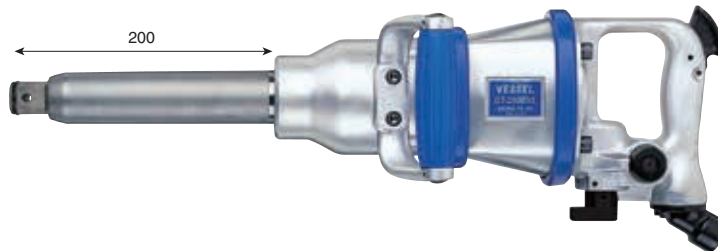

GT-3900V

- 25.4 Retainer ring
- ④ Adjust dial



Ordinary Bolt Dia. **48mm** Compact, lightweight and high power with V shape hammer system.

GT-4800VL

- 25.4 Pin-lock
- ④ Adjust dial

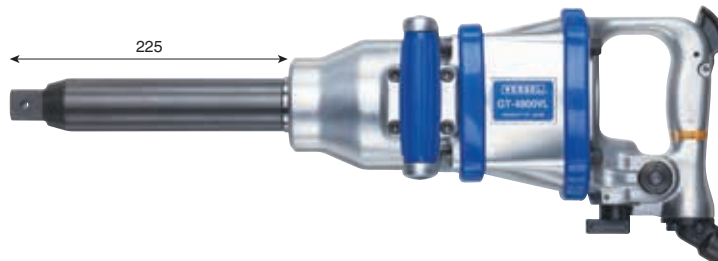

Code No.	Model No.	Capacity Ordinary Bolt Dia. (mm)	Torque Range (N·m)	Max. Torque (N·m)	No Load Speed (rpm)	Air Consumption (m ³ /min)	Hose Coupling	Air Hose Inner Dia. (mm)	Overall Length (mm)	Weight (kg)	Accessories		JAN (4907587)
											Plug	L-wrench	
336118	GT-3900VP	39	490~1716	2013.4	4,200	0.7	Rc 3/8	12.7	268	7.95	BPB-3	H5,H6	304971
336117	GT-3900VL	39	490~1716	2094.9	4,200	0.7	Rc 1/2	12.7	524	8.95	BPB-4	H5,H6	304889
336113	GT-3900V	39	490~1716	2094.9	4,200	0.7	Rc 1/2	12.7	358.6	8.2	BPB-4	H5,H6	304803
336121	GT-4800VL	48	343~2010	2542.1	3,200	1.0	Rc 1/2	12.7	559	12.8	BPB-4	H5,H6	304872

● Air pressure: 0.6MPa ● Overall length and Weight: Accessories not included. ● Capacity is listed as instant reference and varies depending on operation conditions.

HAND TOOLS

INDUSTRIAL BITS

CONSTRUCTION BITS

RECIPROCATING SAW BLADES

ELECTRIC TOOLS

AIR TOOLS

AIR NIPPERS

STATIC SOLUTIONS

GASOLINE ENGINE TOOLS

Air Impact Wrenches Lightweight F-Hammer

● Ordinary Bolt Dia. **20mm** Models with the best balance between strength and lightness.

GT-2000PF

- 19 Retainer ring
- 4 Adjust dial
- Rear exhaust/Noise reducer
- RoHS



ONE POINT

Lightweight F-type Hammer

The rotation of the air motor is transmitted to the hammer, which generates powerful torque by its striking force on the anvil. Feature: pinless hammer that is lightweight, compact, and has high torque output.

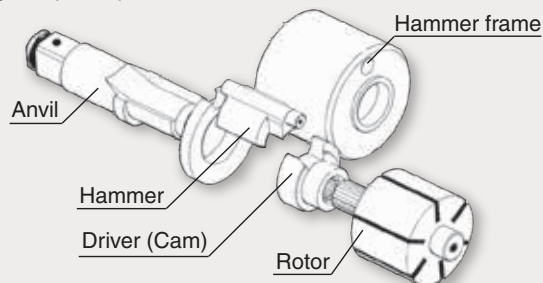

● Ordinary Bolt Dia. **25mm** Models with the best balance between strength and lightness.

GT-2500PF

- 19 Retainer ring
- 4 Adjust dial
- Rear exhaust/Noise reducer



GT-2500LF

- 19 Retainer ring
- 4 Adjust dial

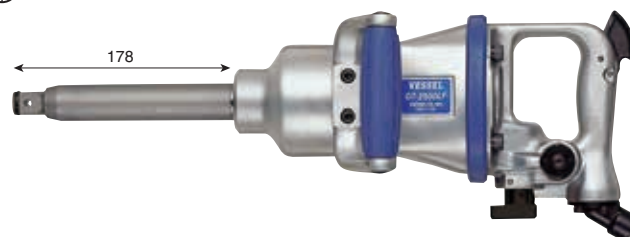

● Ordinary Bolt Dia. **39mm** Models with the best balance between strength and lightness.

GT-3800LX

- 25.4 Retainer ring
- 3 Adjust dial
- Rear exhaust/Noise reducer
- Patented

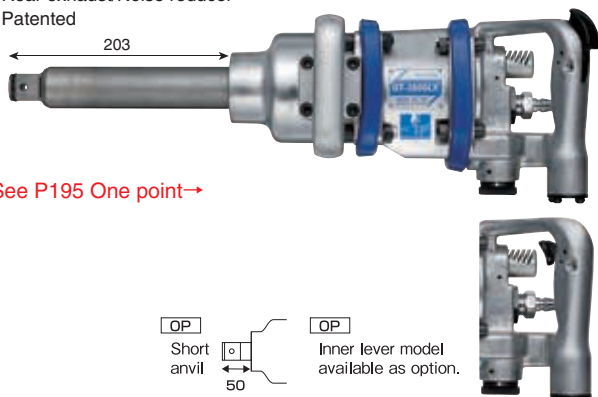

See P195 One point→

GT-3800PX

- 25.4 Retainer ring
- Rear exhaust/Noise reducer



Code No.	Model No.	Capacity Ordinary Bolt Dia. (mm)	Torque Range (N·m)	Max. Torque (N·m)	No Load Speed (rpm)	Air Consumption (m ³ /min)	Hose Coupling	Air Hose Inner Dia. (mm)	Overall Length (mm)	Weight (kg)	Accessories		JAN (4907587)
											Plug	L-wrench	
331298	GT-2000PF	20	98~460.9	542.7	5,500	0.43	Rc 1/4	9.5	210	3.5	BPB-2	H5	304513
335326	GT-2500PF	25	147~961	1187.7	3,200	0.6	Rc 3/8	9.5	242	6.2	BPB-3	H5	304520
335321	GT-2500LF	25	245~961	1315.2	4,400	0.7	Rc 3/8	9.5	478	7.3	BPB-3	H5,H6	304537
335373	GT-3800LX	39	490~1607	2082.3	4,100	0.7	Rc 1/2	12.7	520	9.8	BPB-4	H5	303226
335389	GT-3800PX	39	490~1607	2063	4,100	0.7	Rc 1/2	12.7	270	8.9	BPB-4	H5	303202

● Air pressure: 0.6MPa ● Overall length and Weight: Accessories not included. ● Capacity is listed as instant reference and varies depending on operation conditions.

HAND TOOLS
INDUSTRIAL BITS
CONSTRUCTION BITS
RECIPROCATING SAW BLADES
ELECTRIC TOOLS
AIR TOOLS
AIR NIPPERS
STATIC SOLUTIONS
GASOLINE ENGINE TOOLS

● Ordinary Bolt Dia. **42mm** Models with the best balance between strength and lightness.

GT-4200PF

25.4 Pin-lock

④ Adjust dial



← See P194 One point

● Ordinary Bolt Dia. **52mm** Models with the best balance between strength and lightness.

GT-S55R

25.4 Pin-lock

④ Adjust dial

● Noise reducer

RoHS

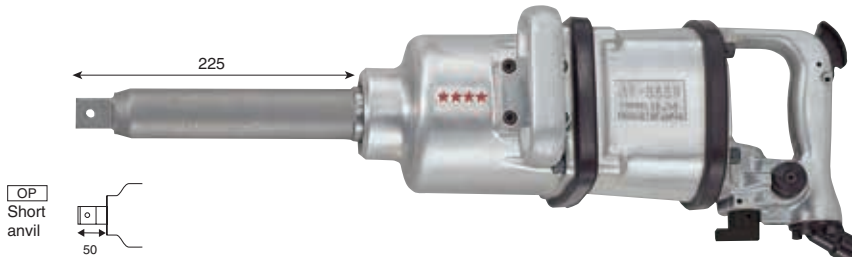

← See P194 One point

Code No.	Model No.	Capacity Ordinary Bolt Dia. (mm)	Torque Range (N·m)	Max. Torque (N·m)	No Load Speed (rpm)	Air Consumption (l/min)	Hose Coupling	Air Hose Inner Dia. (mm)	Overall Length (mm)	Weight (kg)	Accessories		JAN (4907587)
											Plug	L-wrench	
335388	GT-4200PF	42	343~1863	2250	2,500	1.0	Rc 3/8	12.7	297	11.5	BPB-3	H5,H6	304711
335391	GT-S55R	52	343~2450	3000	2,800	1.2	Rc 1/2	12.7	610	17.0	BPB-4	H5,H6	304735

● Air pressure: 0.6MPa ● Overall length and Weight: Accessories not included. ● Capacity is listed as instant reference and varies depending on operation conditions.

ONE POINT

GT-3800LX

Handle shape specialized for working with tires.

Designed so that the center of gravity comes to the center of the whole body with the socket and air hose attached. Very recommended to large tire shops replacing many tires a day.

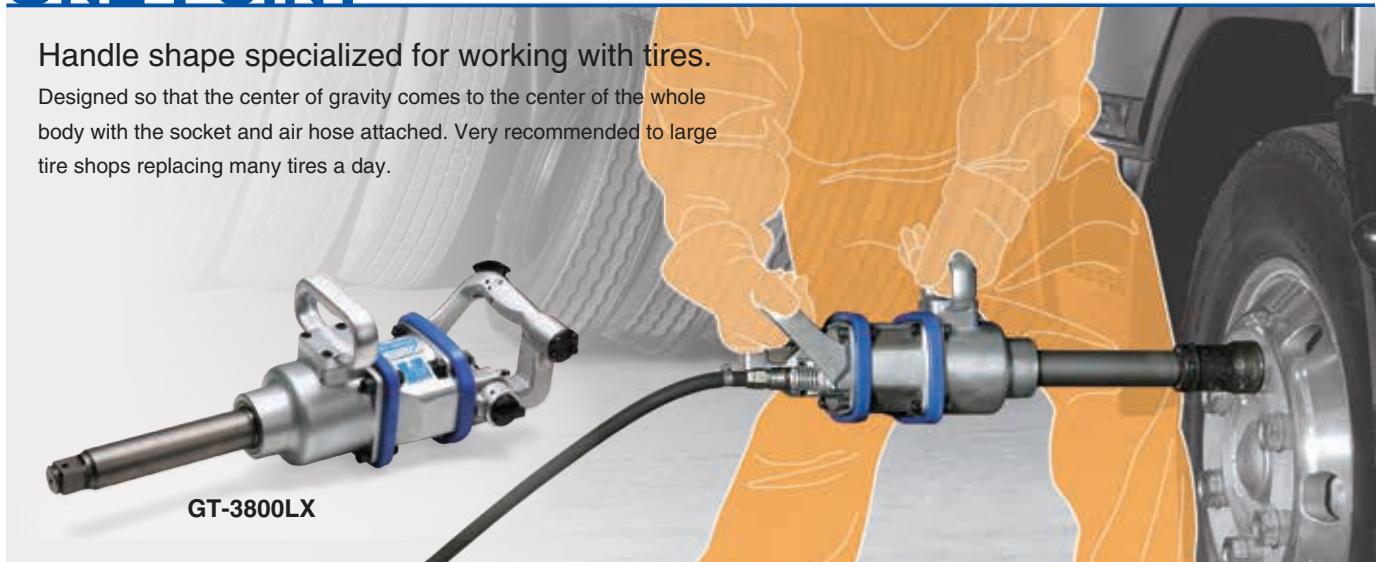

GT-3800LX

HAND TOOLS

INDUSTRIAL BITS

CONSTRUCTION BITS

RECIPROCATING SAW BLADES

ELECTRIC TOOLS

AIR TOOLS

AIR NIPPERS

STATIC SOLUTIONS

GASOLINE ENGINE TOOLS

Air Impact Wrenches Single Hammer

Ordinary Bolt Dia. **6~8mm** For strong tightening work. Excellent durability.

GT-S650

9.5 Retainer ring

4 Adjust dial

RoHS



GT-P6II

9.5 Retainer ring

3 Adjust dial

RoHS



Ordinary Bolt Dia. **8~10mm** For strong tightening work. Excellent durability.

GT-P8II

12.7 Retainer ring

3 Adjust dial

RoHS



Ordinary Bolt Dia. **10mm** Corner type impact wrench.

GT-C900

9.5 Retainer ring

4 Adjust dial

● Patented

RoHS



Ordinary Bolt Dia. **14mm** Corner type impact wrench.

GT-C1400

12.7 Retainer ring

4 Adjust dial

● Patented

RoHS



Code No.	Model No.	Capacity Ordinary Bolt Dia. (mm)	Torque Range (N·m)	Max. Torque (N·m)	No Load Speed (rpm)	Air Consumption (m ³ /min)	Hose Coupling	Air Hose Inner Dia. (mm)	Overall Length (mm)	Weight (kg)	Accessories		JAN (4907587)
											Plug	L-wrench	
331221	GT-S650	6~8	49~121.6	140.5	7,500	0.35	Rc 1/4	6.35	210	1.3	BPB-2	H4	303080
331234	GT-P6II	6~8	49~121.6	140.5	8,500	0.38	Rc 1/4	6.35	146	1.43	BPB-2	H4	303172
331244	GT-P8II	8~10	49~259.8	295.3	7,500	0.4	Rc 1/4	6.35	166	1.89	BPB-2	H4	303356
331228	GT-C900	10	49~100	131.7	7,000	0.25	Rc 1/4	6.35	257	1.9	BPB-2	H3,H4	303301
331227	GT-C1400	14	49~220	241.8	4,500	0.3	Rc 1/4	6.35	277	2.8	BPB-2	H4,H5	303295

● Air pressure: 0.6MPa ● Overall length and Weight: Accessories not included. ● Capacity is listed as instant reference and varies depending on operation conditions.

HAND TOOLS

INDUSTRIAL BITS

CONSTRUCTION BITS

RECIPROCATING SAW BLADES

ELECTRIC TOOLS

AIR TOOLS

AIR NIPPERS

STATIC SOLUTIONS

GASOLINE ENGINE TOOLS

● Ordinary Bolt Dia. **14mm** For strong tightening work. Excellent durability.

GT-P12

12.7 Retainer ring

④ Adjust dial

RoHS



GT-1400P

12.7 Retainer ring

④ Adjust dial

RoHS



● Ordinary Bolt Dia. **16mm** For strong tightening work. Excellent durability. Long anvil model also available.

GT-P14J

12.7 Retainer ring

④ Adjust dial

RoHS



GT-P14JL

12.7 Retainer ring

④ Adjust dial

RoHS



GT-1600P

12.7 Retainer ring

④ Adjust dial

RoHS



ONE POINT

Single Hammer

The rotation of the air motor is transmitted to the hammer, which generates powerful torque by its striking force on the anvil. The "one strike per revolution" structure features high power work. Popular for the automotive maintenance in which the stuck wheel nuts should be loosened.

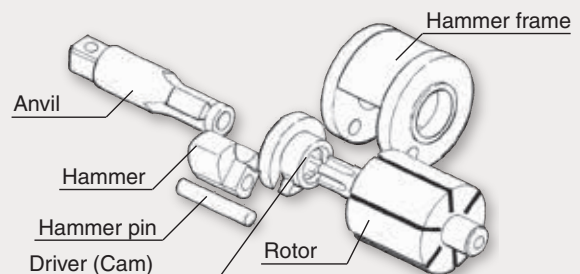

Code No.	Model No.	Capacity Ordinary Bolt Dia. (mm)	Torque Range (N·m)	Max. Torque (N·m)	No Load Speed (rpm)	Air Consumption (m ³ /min)	Hose Coupling	Air Hose Inner Dia. (mm)	Overall Length (mm)	Weight (kg)	Accessories		JAN (4907587)
											Plug	L-wrench	
331262	GT-P12	12~14	49~294.1	344.9	7,500	0.4	Rc 1/4	6.35	185	2.3	BPB-2	H4	303431
331265	GT-1400P	12~14	49~294.1	344.9	7,000	0.35	Rc 1/4	6.35	182	2.25	BPB-2	H4	304131
331272	GT-P14J	14~16	75~323.6	409.6	6,500	0.42	Rc 1/4	6.35	197	2.95	BPB-2	H5	303547
331276	GT-P14JL	14~16	75~323.6	365.0	6,500	0.42	Rc 1/4	6.35	226	3.0	BPB-2	H5	303561
331275	GT-1600P	14~16	75~308.9	362.3	6,700	0.36	Rc 1/4	6.35	196	2.7	BPB-2	H5	304155

● Air pressure: 0.6MPa ● Overall length and Weight: Accessories not included. ● Capacity is listed as instant reference and varies depending on operation conditions.

Air Impact Wrenches Single Hammer

Ordinary Bolt Dia. **20mm** For strong tightening work. Excellent durability. Long anvil model also available.

GT-P18J

19 Retainer ring

4 Adjust dial

RoHS



GT-P18JL

19 Retainer ring

4 Adjust dial

RoHS



GT-2000P

19 Retainer ring

4 Adjust dial

RoHS



Ordinary Bolt Dia. **33mm** For strong tightening work.

GT-P32J

25.4 Retainer ring

4 Adjust dial

RoHS



Ordinary Bolt Dia. **42mm** For strong tightening work. Excellent durability.

GT-4200P

25.4 Pin-lock

4 Adjust dial

RoHS



GT-4200

25.4 Pin-lock

4 Adjust dial

RoHS



Code No.	Model No.	Capacity Ordinary Bolt Dia. (mm)	Torque Range (N·m)	Max. Torque (N·m)	No Load Speed (rpm)	Air Consumption (mj/min)	Hose Coupling	Air Hose Inner Dia. (mm)	Overall Length (mm)	Weight (kg)	Accessories		JAN (4907587)
											Plug	L-wrench	
331292	GT-P18J	16~20	98~470.7	556.5	5,000	0.52	Rc 1/4	9.5	240	4.2	BPB-2	H5	303639
331296	GT-P18JL	16~20	98~441.3	471.4	5,000	0.52	Rc 1/4	9.5	353	4.7	BPB-2	H5	303653
331295	GT-2000P	16~20	98~470.7	556.5	5,000	0.45	Rc 1/4	9.5	241	4.3	BPB-2	H5	304216
335181	GT-P32J	33	343~1569	1906.9	3,700	0.8	Rc 3/8	12.7	264	11.2	BPB-3	H6	030405
331335	GT-4200P	27~42	490~1863	2250	2,500	1.0	Rc 3/8	12.7	315	14.2	BPB-3	H5,H6	304414
335377	GT-4200	27~42	490~1863	2267	3,200	1.0	Rc 1/2	12.7	403	14.9	BPB-4	H5,H6	304421

● Air pressure: 0.6MPa ● Overall length and Weight: Accessories not included. ● Capacity is listed as instant reference and varies depending on operation conditions.

HAND TOOLS
INDUSTRIAL BITS
CONSTRUCTION BITS
RECIPROCATING SAW BLADES
ELECTRIC TOOLS
AIR TOOLS
AIR NIPPERS
STATIC SOLUTIONS
GASOLINE ENGINE TOOLS

Air Impact Wrenches Double Hammer Oil Xtra Series

Ordinary Bolt Dia. **6~8mm** Low noise and low vibration. High power and high durability.



GT-S60XW

- 9.5 Pin-lock
- 3 Adjust dial
- Noise reducer/Rear exhaust
- RoHS

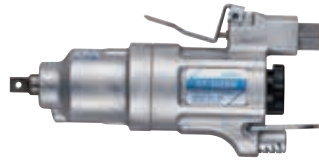

←See P179



GT-P60XW

- 9.5 Pin-lock
- 3 Adjust dial
- Noise reducer/Rear exhaust
- RoHS



←See P179



Ordinary Bolt Dia. **8~10mm** Low noise and low vibration. High power and high durability.

GT-P80XW

- 12.7 Pin-lock
- 4 Adjust dial
- Noise reducer/Rear exhaust



ONE POINT

Double Hammer

The rotation of the air motor is transmitted to the hammer, which generates powerful torque by its striking force on the anvil. The "two blows per revolution" structure features smooth and speedy tightening force. Designed for production lines that give importance to screw tightening efficiency.

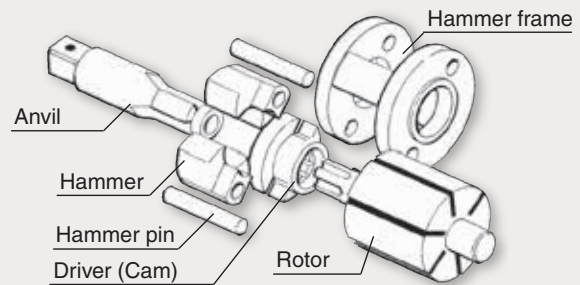

Code No.	Model No.	Capacity Ordinary Bolt Dia. (mm)	Torque Range (N·m)	Max. Torque (N·m)	No Load Speed (rpm)	Air Consumption (m ³ /min)	Hose Coupling	Air Hose Inner Dia. (mm)	Overall Length (mm)	Weight (kg)	Accessories		JAN (4907587)
											Plug	L-wrench	
324022	GT-S60XW	6~8	49~116.8	135.0	7,500	0.38	Rc 1/4	6.35	192	1.0	BPB-2	—	302151
324020	GT-P60XW	6~8	49~116.8	135.0	7,500	0.38	Rc 1/4	6.35	169.4	1.1	BPB-2	—	302182
324049	GT-P80XW	8~10	49~229.7	242.9	7,000	0.4	Rc 1/4	6.35	163.5	1.48	BPB-2	H4	301666

● Air pressure: 0.6MPa ● Overall length and Weight: Accessories not included. ● Capacity is listed as instant reference and varies depending on operation conditions.

Air Impact Wrenches Double Hammer

Ordinary Bolt Dia. **6~8mm** Corner type impact wrench.

GT-S60CW

9.5 Pin-lock

4 Adjust dial

RoHS

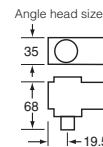

Ordinary Bolt Dia. **6~8mm** For powerful constant fastening. Excellent durability.

GT-S65W

9.5 Pin-lock

4 Adjust dial

RoHS



GT-P65W

9.5 Pin-lock

3 Adjust dial

RoHS



GT-S70WK

9.5 Pin-lock

4 Adjust dial

● Noise reducer/Rear exhaust

RoHS



Ordinary Bolt Dia. **8~10mm** For powerful constant fastening.

GT-P80W

12.7 Pin-lock

3 Adjust dial

RoHS



Ordinary Bolt Dia. **12~16mm** For powerful constant fastening.

GT-P14W

12.7 Pin-lock

4 Adjust dial

RoHS



Code No.	Model No.	Capacity Ordinary Bolt Dia. (mm)	Torque Range (N·m)	Max. Torque (N·m)	No Load Speed (rpm)	Air Consumption (l/min)	Hose Coupling	Air Hose Inner Dia. (mm)	Overall Length (mm)	Weight (kg)	Accessories			JAN (4907587)
											Socket	Plug	L-wrench	
324011	GT-S60CW	6~8	25~47	51.5	7,300	0.35	Rc 1/4	6.35	255	1.87	A/F10	BPB-2	H4	302212
324008	GT-S65W	6~8	49~121.6	140.5	7,500	0.35	Rc 1/4	6.35	210	1.3	A/F10	BPB-2	H4	302168
324038	GT-P65W	6~8	49~121.6	140.5	8,500	0.38	Rc 1/4	6.35	146	1.43	A/F10	BPB-2	H4	302175
324017	GT-S70WK	6~8	85~176.5	193.5	7,000	0.39	Rc 1/4	6.35	231	1.3	—	BPB-2	H4	302229
324048	GT-P80W	8~10	49~259.8	295.3	7,500	0.4	Rc 1/4	6.35	164	1.89	A/F14	BPB-2	H4	302335
324073	GT-P14W	12~16	49~421.6	505.0	6,400	0.47	Rc 1/4	9.5	200	3.2	A/F22	BPB-2	H5	302373

● Air pressure: 0.6MPa ● Overall length and Weight: Accessories not included. ● Capacity is listed as instant reference and varies depending on operation conditions.

HAND TOOLS

INDUSTRIAL BITS

CONSTRUCTION BITS

RECIPROCATING SAW BLADES

ELECTRIC TOOLS

AIR TOOLS

AIR NIPPERS

STATIC SOLUTIONS

GASOLINE ENGINE TOOLS

Ordinary Bolt Dia. **20mm** For powerful constant fastening.

GT-S20RW

19 Pin-lock

4 Adjust dial



Ordinary Bolt Dia. **33mm** For powerful constant fastening.

GT-S32RW

25.4 Pin-lock

4 Adjust dial

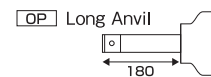

Code No.	Model No.	Capacity Ordinary Bolt Dia. (mm)	Torque Range (N·m)	Max. Torque (N·m)	No Load Speed (rpm)	Air Consumption (m ³ /min)	Hose Coupling	Air Hose Inner Dia. (mm)	Overall Length (mm)	Weight (kg)	Accessories		JAN (4907587)
											Plug	L-wrench	
324101	GT-S20RW	20	75~610	928	4,800	0.9	Rc 3/8	9.5	300	5.4	BPB-3	H5	—
324088	GT-S32RW	33	343~1,569	1801.2	3,600	1.0	Rc 1/2	12.7	380	12.2	BPB-4	H5,H6	302557

● Air pressure: 0.6MPa ● Overall length and Weight: Accessories not included. ● Capacity is listed as instant reference and varies depending on operation conditions.

Air Ratchet Wrenches

Ordinary Bolt Dia. **10mm** This ratchet tightening system makes it possible to fine-tune the wrenching torque.

GT-R10M

9.5 Ball-lock Mini type

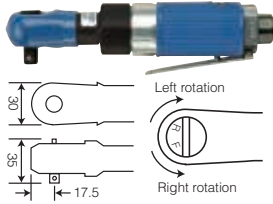

GT-R10

9.5 Ball-lock

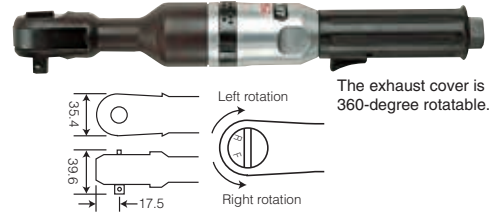

Code No.	Model No.	Capacity Ordinary Bolt Dia. (mm)	No Load Speed (rpm)	Air Consumption (mj/min)	Hose Coupling	Air Hose Inner Dia. (mm)	Overall Length (mm)	Weight (kg)	Accessories Plug	JAN (4907587)
339003	GT-R10M	10	250	0.3	Rc 1/4	6.35	170	500	BPB-2	305534
339001	GT-R10	10	160	0.4	Rc 1/4	6.35	297	1,090	BPB-2	305510

● Air pressure: 0.6MPa ● Overall length and Weight: Accessories not included.

Air Impact Wrenches, Torque Control Type

Ordinary Bolt Dia. **6~8mm** Automatic suspensions by torque set-up

GT-P6T

9.5 Pin-lock

● Adjust dial

RoHS



Code No.	Model No.	Capacity Ordinary Bolt Dia. (mm)	Torque Range (N·m)	No Load Speed (rpm)	Air Consumption (mj/min)	Hose Coupling	Air Hose Inner Dia. (mm)	Overall Length (mm)	Weight (kg)	Accessories		JAN (4907587)
										Plug	L-wrench	
324003	GT-P6T	6~8	7.8~17.6	3,000	0.27	Rc 1/4	6.35	246	1.5	BPB-2	H3,H4	305114

● Air pressure: 0.6MPa ● Overall length and Weight: Accessories not included. ● Capacity is listed as instant reference and varies depending on operation conditions.

HAND TOOLS

INDUSTRIAL BITS

CONSTRUCTION BITS

RECIPROCATING SAW BLADES

ELECTRIC TOOLS

AIR TOOLS

AIR NIPPERS

STATIC SOLUTIONS

GASOLINE ENGINE TOOLS

GT-HPS160
Power Scaler

Spatters even in deep places can be removed as aimed.



Can remove the spatters and slags by lightly pressing the needles. Since the hand is not caught by the recoil, the spread of the needle is reduced, making it easier to securely remove as aimed.



GT-HPS160
Power Scaler

Can handle smoothly even in places that are too deep for the pistol type to fit.

HAND TOOLS

INDUSTRIAL BITS

CONSTRUCTION BITS

RECIPROCATING SAW BLADES

ELECTRIC TOOLS

AIR TOOLS

AIR NIPPERS

STATIC SOLUTIONS

GASOLINE ENGINE TOOLS

Power Scalers

- The barycenter is at the front side, alleviating the strain on your wrist. Downward-facing work on a welding bench is easy and effortless.
- With a new shape similar to the straight type, it can be handled smoothly even in places set deep at a place where the pistol types cannot reach.
- Needles do not spread as much, enabling to aim at the welding spatters and to perform a precise work. ● Easy to replace needles without any tools.
- The hose rotates 360°, making it easier to handle. Equipped with a filter to prevent dust coming in from the air inlet.
- Convenient for removing spatters or slugs, peeling off coating and removing rust.

Needle ϕ 2mm

GT-HPS160

- Needle ϕ 2mm×180mm.....29pcs.
- Accessories Hose set.....1set
Hydraulic oil for hammer unit.....1pc.
(VG-10·White)
Replacement needles.....29pcs.
(ϕ 2mm×180mm)



RoHS

←See P203

Needle ϕ 3mm

GT-HPS200

- Needle ϕ 3mm×180mm.....12pcs.
- Accessories Hose set.....1set
Hydraulic oil for hammer unit.....1pc.
(VG-10·White)
Replacement needles.....12pcs.
(ϕ 3mm×180mm)



RoHS

←See P203

Code No.	Model No.	Piston Dia. (mm)	Needle Stroke (mm)	Number of Impacts (min ⁻¹)	Air Consumption (m ³ /min)	Inlet Bushing	Appropriate Air Pressure (MPa)	Air Hose Inner Dia. (mm)	Overall Length (mm)	Weight (kg)	JAN (4907587)
310650	GT-HPS160	16	18	4000	0.22	Rc 1/4	0.6	6.35	380	1.47	305282
310651	GT-HPS200	20	20	3700	0.26	Rc 1/4	0.6	6.35	400	1.9	305299

※Overall length and weight : Accessories included

Needles for Power Scalers

HPSN-215

RoHS



HPSN-318

RoHS



HPSN-218

RoHS



For GT-HPS160(100pieces)

Code No.	Model No.	Contents	JAN (4907587)
350151	HPSN-215	ϕ 2mm×150mm 100pcs.	317469
350150	HPSN-218	ϕ 2mm×180mm 100pcs.	317452

For GT-HPS200(50pieces)

Code No.	Model No.	Contents	JAN (4907587)
350152	HPSN-318	ϕ 3mm×180mm 50pcs.	317476

HAND TOOLS

INDUSTRIAL BITS

CONSTRUCTION BITS

RECIPROCATING SAW BLADES

ELECTRIC TOOLS

AIR TOOLS

AIR NIPPERS

STATIC SOLUTIONS

GASOLINE ENGINE TOOLS

GT-DG50
Air Disc Grinder

Pursuit of safety and usability.

Lock lever to fix the spindle when the button is pressed.
No need for a wrench when changing grinding wheels.
Comfort-to-operate and non-slip soft grip.
The GT-DG100 is equipped with a governor mechanism.

GT-DG50
Air Disc Grinder

Ideal for tight spaces! Compact size improves workability. Uses a high-torque air motor that does not stop even if the machine is pressed down.



※Image is for illustration purposes.

Air Belt Sanders

Belt Width 12mm/10mm Compact and lightweight.

GT-BS12

- With noise reducer
- Accessories
 - Sand belt #60...2pcs.
 - #80...1pc.
- Patented

RoHS



Belt Width 20mm Roller head can be chosen.

GT-BS20

- Aluminum roller head
- With noise reducer
- Patented

RoHS



Aluminum
For heavy-duty sanding.

- Accessories
 - Sand belt #60...2pcs.
 - #80...1pc.



OP
Bar grip
(Auxiliary handle)

Code No.	Model No.	Applicable Belt Size (mm)	Belt Circumferential Speed (m/min)	Working Air Pressure (MPa)	No Load Speed (rpm)	Air Consumption (m³/min)	Hose Coupling	Overall Length (mm)	Weight (g)	Accessories		JAN (4907587)
										Plug	L-wrench	
310621	GT-BS12	12/10×330	1,100	0.6	17,000	0.52	Rc 1/4	311	840	BPB-2	H1.5	304933
310622	GT-BS20	20×520	2,600	0.6	16,500	0.6	Rc 1/4	398	1,300	BPB-2	H2	304988

● Total length: When mounted with belt.

Air Disk Sanders

Disk Dia. 50mm Low speed of 5000 rpm & High torque.

GT-DS50A

- With noise reducer
- Accessories
 - Flap wheel #60...1pc.
 - Fiber wheel #600...1pc.
 - Pitatto holder 1pc.
 - Pitatto disk paper #60...3pcs.

RoHS

Collet chuck
φ6mm



OP
Collet chuck (φ3mm, φ1/4", φ1/8")



Disk Dia. 100mm Low speed of 5000 rpm & High torque.

GT-DS50B

- With noise reducer
- Accessories
 - Protective cover
 - M10 disk nut
 - Disk nut
 - Pin wrench

RoHS

M10 disk nut



OP
Disk bolt



Code No.	Model No.	Disk Dia. (mm)	No Load Speed (rpm)	Air Consumption (m³/min)	Hose Coupling	Air Hose Inner Dia. (mm)	Overall Length (mm)	Weight (g)	Tip Tool Installation Part	Accessories		JAN (4907587)
										Plug	Spanner	
310635	GT-DS50A	Disk Dia. 50	5,000	0.65	Rc 1/4	6.35	211	935	Collet chuck φ6mm	BPB-2	H11,H15	305541
310636	GT-DS50B	Disk Dia.100	5,000	0.65	Rc 1/4	6.35	211	1,150	Disk nut M10	BPB-2	Pin wrench,H15	305558

● Air pressure: 0.6MPa

HAND TOOLS

INDUSTRIAL BITS

CONSTRUCTION BITS

RECIPROCATING SAW BLADES

ELECTRIC TOOLS

AIR TOOLS

AIR NIPPERS

STATIC SOLUTIONS

GASOLINE ENGINE TOOLS

Endless belts for air belt sander

Ceramic Endless Belt (for GT-BS12)

RoHS



Code No.	Model No.	Size	Grit No.	Quantity	JAN (4907587)
350061	CB12-60	12mm×330mm	#60	50	017260
350062	CB12-80	12mm×330mm	#80	50	017277
350064	CB12-120	12mm×330mm	#120	50	017291

Zirconia Endless Belt (for GT-BS20)

RoHS



Code No.	Model No.	Size	Grit No.	Quantity	JAN (4907587)
350067	ZB20-40	20mm×520mm	#40	20	017307
350068	ZB20-60	20mm×520mm	#60	20	017314
350069	ZB20-80	20mm×520mm	#80	20	017321

Air Disk Sander Wheel (For DS50A)

PD-P60

Pitatto Disk Paper (50 Sheets Included)

RoHS

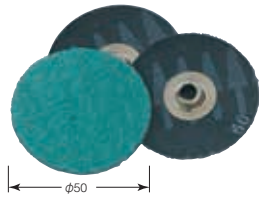

PD-P6

Pitatto Holder

RoHS



Code No.	Model No.	Grit No.	Max. Circumferential Speed (rpm)	Material	Use	Quantity	JAN (4907587)
350111	PD-P60	Z60	20,000	Zirconia	Thin pressed plate deburring, surface grinding, etc.	1	317278
350116	PD-P6	—	—	Rubber (Pad)	For Pitatto disk paper	1	317285

Wheels to Remove Rust / Stains (For DS50B)

Hammer Wheel

RoHS

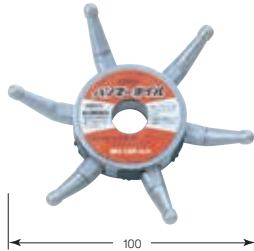

Code No.	Model No.	Max. Circumferential Speed (rpm)	Material	Use	Quantity	JAN (4907587)
350121	HMW10	5,000	SUS	Slag and spatter removal after welding, etc.	1	317292

ONE POINT

Applications	Wheels	Tools
<ul style="list-style-type: none"> ● Deburring in thin plate pressing process or from aluminum casting, removal of cutter mark, and woodworking. 	Pitatto Holder + Pitatto Disc Paper 	GT-DS50A
<ul style="list-style-type: none"> ● Removal of slags and spatters after welding, of rust from steel, or of shells from the bottom of the ship, and deburring of castings. 	Hammer Wheel 	GT-DS50B

HAND TOOLS

INDUSTRIAL BITS

CONSTRUCTION BITS

RECIPROCATING SAW BLADES

ELECTRIC TOOLS

AIR TOOLS

AIR NIPPERS

STATIC SOLUTIONS

GASOLINE ENGINE TOOLS

Air Disk Grinders

Disk Dia. **50mm** Handy & powerful grinder pursuing safety and usability.

GT-DG50

RoHS

← See P205



Code No.	Model No.	Grindstone Size Outer Dia.×Thickness×Hole Dia. (mm)	Max Operating Circumferential Speed (m/s)	No Load Speed (rpm)	Air Consumption (m ³ /min)	Hose Coupling	Overall Length (mm)	Height (mm)	Weight (g)	Accessories		JAN (4907587)
										Plug	L-wrench	
310639	GT-DG50	50×4×9.5	39.2	15,000	0.57	Rc 1/4	164	47	800	BPB-2	H5	007889

● Air pressure: 0.6MPa ● Air hose ID: 6.35mm

Disk Dia. **100mm** Handy & powerful grinder pursuing safety and usability.

GT-DG100

RoHS



OP
Bar grip (Auxiliary handle)

Code No.	Model No.	Grindstone Size Outer Dia.×Thickness×Hole Dia. (mm)	Max Operating Circumferential Speed (m/s)	No Load Speed (rpm)	Air Consumption (m ³ /min)	Hose Coupling	Overall Length (mm)	Height (mm)	Weight (g)	Accessories		JAN (4907587)
										Plug	L-wrench	
310630	GT-DG100	100×6×15	70.6	13,500	0.7	Rc 1/4	218.5	92	1,390	BPB-2	H6	304995

● Air pressure: 0.6MPa ● Air hose ID: 6.35mm

ONE POINT

GT-DG100

Handy & powerful grinder pursuing safety and usability.

Lateral exhaust port.
Exhausted air is not blown over the workpiece and dust is not blown up.



Spindle lock. No need for a wrench when changing grinding wheels. Press the button to fix the spindle.

Built-in safety governor (speed regulator). The speed regulator controls the increase and decrease of the rotation speed between no-load and loaded operation to stabilize the rotation.

Deburring of various steel materials, cast iron, etc. Grinding and finishing of welded and fused parts. Removal of rust of iron materials or paint. Cutting of thin steel plates, small diameter round bars, etc. Cutting and surface finishing of resins, roof tiles, tiles, bricks, stones, etc.



HAND TOOLS

INDUSTRIAL BITS

CONSTRUCTION BITS

RECIPROCATING SAW BLADES

ELECTRIC TOOLS

AIR TOOLS

AIR NIPPERS

STATIC SOLUTIONS

GASOLINE ENGINE TOOLS

Air Micro Grinders (For Precision Grinding)

Collet chuck $\phi 3\text{mm}$ Effortless and smooth grinding at high speed and without runaway.

GT-MG75S

RoHS

75,000 rpm



GT-MG75SAR

Soft Grip

RoHS

75,000 rpm



OP Collet chuck ($\phi 2.35\text{mm}, \phi 1/8''$)

GT-MG55SR

Ergo Grip

RoHS

55,000 rpm



GT-MG55SAR

Soft Grip

RoHS

55,000 rpm



OP Collet chuck ($\phi 2.35\text{mm}, \phi 1/8''$)

GT-MG55S

RoHS

55,000 rpm



GT-MG35-12CC

Soft Grip

RoHS

35,000 rpm



OP Collet chuck ($\phi 2.35\text{mm}, \phi 1/8''$)

OP Corner attachment

GT-MG25-12CF (Smooth grinding / polishing at 25,000 rpm)
GT-MG25-12CC (Precision grinding at 25,000 rpm)

Collet chuck $\phi 6\text{mm}$ Effortless and smooth grinding at high speed and without runaway.

GT-MG25S

RoHS

25,000 rpm



OP Collet chuck ($\phi 3\text{mm}, \phi 1/4'', \phi 1/8''$)

GT-MG35SAR

Soft Grip

RoHS

35,000 rpm



OP Collet chuck ($\phi 3\text{mm}, \phi 1/4'', \phi 1/8''$)

Code No.	Model No.	No Load Speed (rpm)	Air Consumption (m ³ /min)	Hose Coupling	Air Hose Inner Dia. (mm)	Overall Length (mm)	Frame Dia (mm)	Weight (g)	Collet chuck (mm)	Accessories			JAN (4907587)
										Chuck handle	Spanner	Oil	
310725	GT-MG75S	75.000	0.16	Rc 1/4	6.35	170	18.5	190	3	●	H9	●	307156
310726	GT-MG75SAR	75.000	0.16	Rc 1/4	6.35	156	20.9	180	3	—	H5,H9	●	307446
310750	GT-MG55SR	55.000	0.16	Rc 1/4	6.35	180	20.5	220	3	●	H9	●	307118
310773	GT-MG55SAR	55.000	0.245	Rc 1/4	6.35	178	24.4	260	3	—	H5,H9	●	307194
310705	GT-MG55S	55.000	0.16	Rc 1/4	6.35	165	17.5	180	3	●	H9	●	307057
310774	GT-MG35-12CC	35.000	0.2	Rc 1/4	6.35	183	24.5	305	3	—	H5,H9	●	304940
310765	GT-MG25S	25.000	0.175	Rc 1/4	6.35	198	30.0	700	6	—	H11,H13	●	307019
310772	GT-MG35SAR	35.000	0.285	Rc 1/4	6.35	182	29.4	435	6	—	H11,H13	●	307187

● Working air pressure: 0.6MPa ● Overall length: Accessories and exhaust hose parts not included. ● Weight: Accessories not included.
 ● In the main body, a 1.5m air intake hose, exhaust hose and a hose joint are attached. ● With regard to GT-MG55S, MG55SR, MG75S and a 2.35 mm collet chuck is also prepared.
 OP Can be replaced by user. OP Should be replaced at our factory.

HAND TOOLS

INDUSTRIAL BITS

CONSTRUCTION BITS

RECIPROCATING SAW BLADES

ELECTRIC TOOLS

AIR TOOLS

AIR NIPPERS

STATIC SOLUTIONS

GASOLINE ENGINE TOOLS

Air Micro Grinders (Surface Grinding/Polishing)

GT-MG25-12CF

● Soft Grip



25,000 rpm



OP Corner attachment

GT-MG25-12CC (Precision grinding at 25,000 rpm)
GT-MG35-12CC (Precision grinding at 35,000 rpm)

GT-MG25-9CF

● Soft Grip



25,000 rpm



OP Corner attachment

GT-MG25-9CC (Precision grinding at 25,000 rpm)
GT-MG35-9CC (Precision grinding at 35,000 rpm)

Code No.	Model No.	No Load Speed (rpm)	Air Consumption (m ³ /min)	Hose Coupling	Air Hose Inner Dia. (mm)	Overall Length (mm)	Frame Dia (mm)	Weight (g)	Tip tool Attachment Size	Accessories	JAN (4907587)
310776	GT-MG25-12CF	25,000	0.25	Rc 1/4	6.35	181	24.5	315	M7	·Chuck handle ·Oil ·Rubber holder ·PO-ring (#60·100·150·240 3pcs. each #400·600 1pc. each ·Lap ring (#600 1pc.)·Headcup (#80 1pc.)	304964
310775	GT-MG25-9CF	25,000	0.25	Rc 1/4	6.35	173	24.5	310	M7		304957

● Working air pressure: 0.6MPa ● Overall length: Accessories and exhaust hose parts not included. ● Weight: Accessories not included.
 ● In the main body, a 1.5m air intake hose, exhaust hose and a hose joint are attached.

OP Should be replaced at our factory.

Tip Tools for Smooth Surface Grinding and Polishing

To meet work objectives from the removal of cutter marks when manufacturing metal molding, to the finishing of mirror surfaces

Headcup

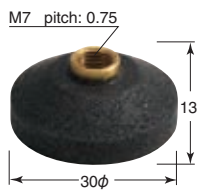

Rubber Holder



PO-Ring



Lap Ring



Code No.	Model No.	Grit #	Inner Ctn.	JAN (4907587)
622205	HC-80	80	10	317155

Code No.	Model No.	Inner Ctn.	JAN (4907587)
622305	RH-30	10	317162

Code No.	Model No.	Grit #	Inner Ctn.	JAN (4907587)
622005	PR-60	60	100	317018
622007	PR-100	100	100	317025
622009	PR-150	150	100	317032
622011	PR-240	240	100	317049
622013	PR-400	400	100	317056
622015	PR-600	600	100	317063

Code No.	Model No.	Grit #	Inner Ctn.	JAN (4907587)
622105	LP-320	320	30	317100

ONE POINT

Replacement of corner attachment heads

Corner attachments with different gear ratios and head shapes are available. We can replace the head upon request.

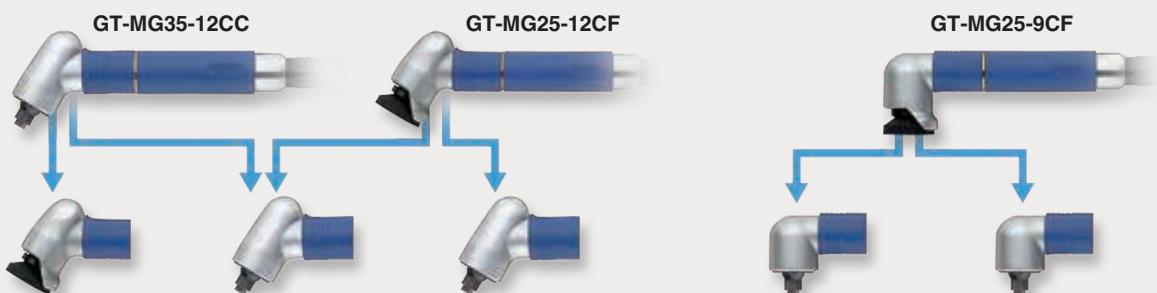

GT-MG25-12CF
 ● No Load Speed 25,000rpm
 ● Tip tool attachment size: M7

GT-MG25-12CC
 ● No Load Speed 25,000rpm
 ● Collet Chuck ID φ3mm

GT-MG35-12CC
 ● No Load Speed 35,000rpm
 ● Collet Chuck ID φ3mm

GT-MG25-9CC
 ● No Load Speed 25,000rpm
 ● Collet Chuck ID φ3mm

GT-MG35-9CC
 ● No Load Speed 35,000rpm
 ● Collet Chuck ID φ3mm

GT-CD60-34L

Air Corner Drill

Optimum for drilling in tight spaces



Ultra small head

For drilling small diameter holes in lightweight or composite materials.

Compact, lightweight, low-noise general-purpose air drill suitable for aircraft manufacturing and maintenance. 3,400 rpm suitable for drilling a variety of materials.

Lever type for firm grip

Flexible inlet to prevent the hose from being kinked.

Excellent drilling accuracy without runout

Cushion & non-slip grip

Rear exhaust

Safe because chips do not fly up.



GT-CD60-34L

Air Corner Drill

Ideal for joining face areas and for drilling holes in narrow and difficult-to-work-in areas. Exquisitely balanced, ultra-compact corner head type.

※Image is for illustration purposes.

HAND TOOLS

INDUSTRIAL BITS

CONSTRUCTION BITS

RECIPROCATING SAW BLADES

ELECTRIC TOOLS

AIR TOOLS

AIR NIPPERS

STATIC SOLUTIONS

GASOLINE ENGINE TOOLS

Air Saws

Cutting Capacity Metal Sheet **4mm** Compact and lightweight.

GT-AS10

- Noise reducer
- Accessories Blade : 32-tooth thick blade ASB-32H...1pc.
24-tooth thick blade ASB-24H...1pc.

RoHS

Easy recovery by the restart button in case of unexpected stop.



Cutting Capacity Metal Sheet **1.6mm** Compact and lightweight.

GT-AS100

- Accessories Blade : 32-tooth standard blade ASB-32...2pcs.

RoHS



Code No.	Model No.	Cutting Capacity	Working Air Pressure (MPa)	Stroke Speed (c.p.m.)	Air Consumption (ml/min)	Stroke (mm)	Hose Coupling	Overall Length (mm)	Weight (g)	Accessories		JAN (4907587)
										Plug	L-wrench	
336131	GT-AS10	Metal sheet...4mm	0.6	5,000	0.28	10	Rc 1/4	195.5	870	BPB-2	H3	304926
310640	GT-AS100	Metal sheet...1.6mm	0.6	10,000	0.34	10	Rc 1/4	170	570	BPB-2	H2,H4	305138

● Cutting capacity: GT-AS10: When used with a No.ABS-32H blade GT-AS100: When used with a No.ASB-32 blade ● Overall Length and Weight: Accessories not included.

Air Saw Blades (For GT-AS10/AS100)

RoHS

(ASB-32 only)

<For steel>



<Scraper>



Code No.	Model No.	Specifications	Use	Quantity	JAN (4907587)
350054	ASB-32	For steel Cobalt mix, standard blade, 32 teeth	Cutting steel	10	017376
350052	ASB-32H	For steel Cobalt mix, super thick blade, 32 teeth	Cutting plain and stainless steel sheet	10	017239
350053	ASB-24H	For steel Cobalt mix, super thick blade, 24 teeth	Cutting aluminum, soft steel and resin	10	017246
350143	ASC-25-5	Scraper 25 mm wide blade	Scraping, peeling, etc.	1	317353

Air Scraper

GT-ASC5

- Noise reducer
- ※ Scraper sold separately

RoHS

Easy recovery by the restart button in case of unexpected stop.



Code No.	Model No.	Working Air Pressure (MPa)	Stroke Speed (c.p.m.)	Air Consumption (ml/min)	Stroke (mm)	Hose Coupling	Overall Length (mm)	Weight (g)	Accessories		JAN (4907587)
									Plug	L-wrench	
336132	GT-ASC5	0.6	7,000	0.28	5	Rc 1/4	195.5	810	BPB-2	H3	302540

Scraper (For GT-ASC5)

ASC-25-8



ASC-50-8



Code No.	Model No.	Blade Width (mm)	Axis Dia. φ (mm)	Use	JAN (4907587)
350141	ASC-25-8	25	8	for IC chip	317339
350142	ASC-50-8	50	8	for IC chip, wall	317346

HAND TOOLS

INDUSTRIAL BITS

CONSTRUCTION BITS

RECIPROCATING SAW BLADES

ELECTRIC TOOLS

AIR TOOLS

AIR NIPPERS

STATIC SOLUTIONS

GASOLINE ENGINE TOOLS

Air Drills

Drill Hole $\phi 6\text{mm}$ Compact, lightweight, and equipped with silencer, providing comfortable functions for drilling.

GT-D60-30

- Noise reducer/ Rear exhaust

RoHS



GT-D60-45

- Noise reducer/ Rear exhaust

RoHS



Heat protection rubber cover.

Drill Hole $\phi 6\text{mm}$ Suitable for drilling holes on curved surfaces and/or hard-to-work-on places.

GT-CD60-34

- Air Corner Drill
- Rear exhaust

←See P211



GT-CD60-34L

- Air Corner Drill
- Rear exhaust

←See P211

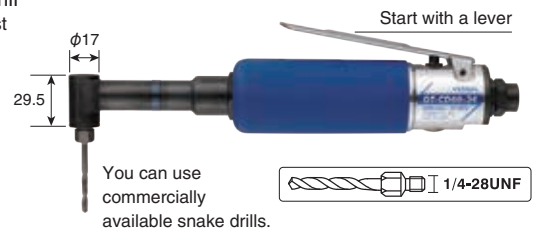

Drill Hole $\phi 8\text{mm}$ Compact, lightweight, and equipped with silencer, providing comfortable functions for drilling.

GT-D80-20

- Noise reducer/ Rear exhaust

RoHS



GT-D80-20K

- Noise reducer/ Rear exhaust

RoHS

Key-less chuck type



Drill Hole $\phi 10\text{mm}$ Compact, lightweight, and equipped with silencer, providing comfortable functions for drilling.

GT-D100-15

- Noise reducer/ Rear exhaust

RoHS



GT-D100-15K

- Noise reducer/ Rear exhaust

RoHS

Key-less chuck type



Code No.	Model No.	Steel Plate Drilling Capacity ϕ (mm)	No Load Speed (rpm)	Air Consumption (ml/min)	Hose Coupling	Air Hose Inner Dia. (mm)	Overall Length (mm)	Weight (g)	Chuck Size	Accessories		JAN (4907587)
										Plug		
310603	GT-D60-30	6	3,000	0.52	Rc 1/4	6.35	188	880	6mm	BPB-2	Chuck handle	305749
310611	GT-D60-45	6	4,500	0.56	Rc 1/4	6.35	188	890	6mm	BPB-2	Chuck handle	305824
336141	GT-CD60-34	6	3,400	0.42	Rc 1/4	6.35	250	820	1/4-28UNF	BPB-2	Lock handle , Offset wrench	305800
336142	GT-CD60-34L	6	3,400	0.42	Rc 1/4	6.35	251	840	1/4-28UNF	BPB-2	Lock handle , Offset wrench	305817
310604	GT-D80-20	8	2,000	0.35	Rc 1/4	6.35	165	940	8mm	BPB-2	Chuck handle	305756
310605	GT-D80-20K	8	2,000	0.35	Rc 1/4	6.35	171	960	8mm	BPB-2	-	305763
310606	GT-D100-15	10	1,500	0.54	Rc 1/4	6.35	189	1,280	10mm	BPB-2	Chuck handle	305770
310607	GT-D100-15K	10	1,500	0.54	Rc 1/4	6.35	195	1,300	10mm	BPB-2	-	305787

• Working air pressure: 0.6MPa • Overall length and Weight: Accessories not included.

AD-4 N
Air Dusters

Lightweight and robust body



AD-2 OR
Air Duster

Two body types for different applications. Combination of materials and ergonomic design has made easy-to-use products. For various blowing or drying work.

ONE POINT

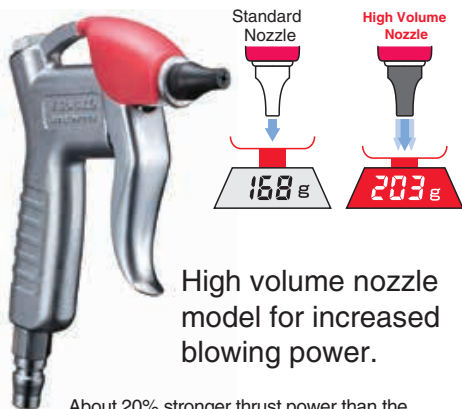

High volume nozzle model for increased blowing power.

About 20% stronger thrust power than the standard nozzle.
Can powerfully discharge chips that have penetrated into the chuck jaws and cutter grooves with large air pressure.

Standard Nozzle **AD-4 N** Standard Type.

AD-4 N/N-PB

RoHS



AD-4 N-PT

RoHS



Flow Volume Adjustment Nozzle **AD-4 J** Can adjust air flow.

AD-4 J/J-PB



AD-4 J-PT



High Volume Nozzle **AD-4 M** Booster nozzle with a higher spraying pressure.

AD-4 M

RoHS



See P214 One point →

Long Nozzle **AD-4 N** For working in deep and distant places.

AD-4 N-150/200/300



Flexible Nozzle **AD-4 NF**

AD-4 NF-150/300

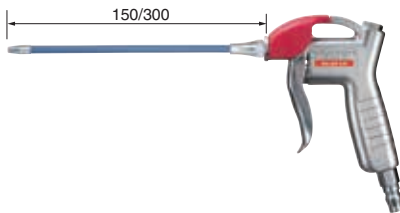

Box package



Can also hang.



Slide package

Code No.	Model No.	Nozzle Type	Nozzle Inner Dia. (mm)	Air Consumption (l/min)	Overall Length (mm)	Weight (g)	Air Hose Connection	Outer Ctn.	Card/ Box Size (mm)	JAN (4907587)
141180	AD-4 N	Standard Nozzle	2	180	125	235	Coupling	20	in paper box 173×110×25	027078
141181	AD-4 N-PB	Standard Nozzle	2	180	125	235	Coupling	10	185×160×30	027085
141182	AD-4 N-PT	Standard Nozzle	2	180	125	235	1/4 Hose	10	185×160×30	027092
141183	AD-4 J	Flow Adjustment Nozzle	2	150	130	240	Coupling	20	in paper box 173×100×25	027108
141184	AD-4 J-PB	Flow Adjustment Nozzle	2	150	130	240	Coupling	10	185×160×30	027115
141185	AD-4 J-PT	Flow Adjustment Nozzle	2	150	130	240	1/4 Hose	10	185×160×30	027122
141187	AD-4 M	High Volume Nozzle	2×1pc., 0.8×4pcs.	230	125	228	Coupling	20	in paper box 173×100×25	027313
141188	AD-4 N-150	Long Nozzle	2.5	230	275	248	Coupling	10	in paper box 300×140×25	027344
141189	AD-4 N-200	Long Nozzle	2.5	230	325	253	Coupling	10	in paper box 450×140×25	027351
141190	AD-4 N-300	Long Nozzle	2.5	230	425	260	Coupling	10	in paper box 450×140×25	027368
141191	AD-4 NF-150	Flexible Nozzle ※	2.3	140	275	260	Coupling	10	in paper box 300×140×25	027375
141193	AD-4 NF-300	Flexible Nozzle ※	2.3	110	425	274	Coupling	10	in paper box 450×140×25	027399

● Working fluid: compressed air ● Working air pressure: 0.5MPa ● Max. working pressure: 0.7MPa ● Working temperature range: 0-60°C ● Working air hose ID: φ4mm and more
 ● Overall length and weight: Air coupler included. ※ It can be bent freely due to the built-in copper tube. (Do not bend it at a steep angle.)

Interchangeable Nozzles (for AD-4) / Brushes (for AD-4 B)

Long Nozzle

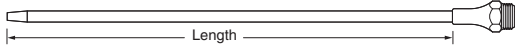

Air Flow Volume Adjustment Long Nozzle

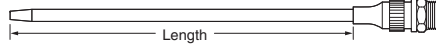

Flexible Nozzle



Plastic Nozzle

Safe and dent-free

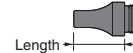

Inlet: G1/8

Long Nozzle

Code No.	Model No.	Inner Dia. (mm)	Outer Dia. (mm)	Length (mm)	Inner Ctn.	JAN (4907587)
141133	LN-150	2.5	5	150	10	027160
141134	LN-200	2.5	5	200	10	027177
141135	LN-300	2.5	5	300	10	027184

Flexible Nozzle Shaft

Code No.	Model No.	Inner Dia. (mm)	Outer Dia. (mm)	Length (mm)	Inner Ctn.	JAN (4907587)
141143	LF-150	2.3	7	150	10	027269
141144	LF-200	2.3	7	200	10	027276
141145	LF-300	2.3	7	300	10	027283

Air Flow Volume Adjustment Long Nozzle

Code No.	Model No.	Inner Dia. (mm)	Outer Dia. (mm)	Length (mm)	Inner Ctn.	JAN (4907587)
141137	LJ-150	2.5	5	150	10	027207
141138	LJ-200	2.5	5	200	10	027214
141139	LJ-300	2.5	5	300	10	027221
141140	LJ-500	2.5	5	500	10	027238

Plastic Nozzle

Code No.	Model No.	Inner Dia. (mm)	Outer Dia. (mm)	Length (mm)	Inner Ctn.	JAN (4907587)
141132	SP-0	2.0	7.5	21	1	027153

RoHS

HAND TOOLS

INDUSTRIAL BITS

CONSTRUCTION BITS

RECIPROCATING SAW BLADES

ELECTRIC TOOLS

AIR TOOLS

AIR NIPPERS

STATIC SOLUTIONS

GASOLINE ENGINE TOOLS

Standard Nozzle **AD-2** To blow off machined chips, moisture, and oil

AD-2 0N



AD-2 0N-PB



Long Nozzle **AD-2 100N/ 200N/ 300N** To blow off machined chips, moisture, and oil

AD-2 100N



AD-2 100N-PB



AD-2 200N/300N



25° Long Nozzle **AD-2 100A** 25° angled tip to improve workability

AD-2 100A

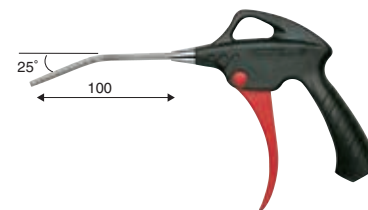

Safety Bypass Nozzle **AD-2 0S** To blow off safely and quietly in a wide area

AD-2 0S



Safety Bypass Long Nozzle **AD-2 100S** To blow off safely and quietly in a wide area

AD-2 100S

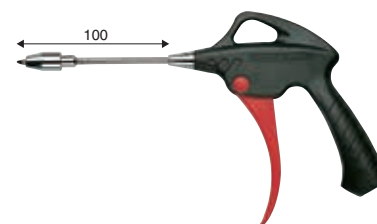

Large lever for operating with 4 fingers. The airflow can be changed by the force of pulling the lever. Ergonomically designed handle for outstanding workability. For removal and blowing of dust, and drying, the work such as steel plate, painting, automotive maintenance, molding, metal processing, and so on.

Code No.	Model No.	Nozzle Type	Nozzle		Air Consumption (l/min)	Overall Length (mm)	Weight (g)	Outer Ctn.	Card/ Box Size (mm)	JAN (4907587)
			Length	Inner Dia. (mm)						
141111	AD-2 0N	Standard Nozzle	0	2.1	135	145	122	10	232×152×30	017604
141151	AD-2 0N-PB	Standard Nozzle (with plug)	0	2.1	135	155	146	10	232×152×30	017680
141112	AD-2 100N	Long Nozzle	100	2.1	135	242	131	10	232×182×30	017611
141152	AD-2 100N-PB	Long Nozzle (with plug)	100	2.1	135	252	157	10	232×182×30	017697
141113	AD-2 200N	Long Nozzle	200	2.1	135	342	141	1	in paper box 360×138×30	017673
141114	AD-2 300N	Long Nozzle	300	2.1	135	442	150	1	in paper box 460×138×30	017628
141115	AD-2 100A	25° Long Nozzle	100	2.1	135	242	131	10	232×182×30	017635
141121	AD-2 0S	Safety Bypass nozzle	0	2.1	105	155.5	131	10	232×152×30	017727
141122	AD-2 100S	Safety Bypass long nozzle	100	2.1	105	239.5	151	10	232×182×30	017734

● Working fluid: compressed air ● Max. working pressure: 0.97MPa ● Working temperature range: 0-60°C (32-140°F) ● Air inlet screw diameter: Rc 1/4 ● Working air hose ID: φ4mm and more ● Air pressure when air consumption is measured: 0.49MPa ● Blister packing (200N, 300N in paper box)

※ Nozzle can not be replaced.

HAND TOOLS

INDUSTRIAL BITS

CONSTRUCTION BITS

RECIPROCATING SAW BLADES

ELECTRIC TOOLS

AIR TOOLS

AIR NIPPERS

STATIC SOLUTIONS

GASOLINE ENGINE TOOLS

Rubber Nozzle **AD-2 0R** Dust blow off, not making scratches on a part

AD-2 0R



Rubber Long Nozzle **AD-2 100R** Dust blow off, not making scratches on a part

AD-2 100R

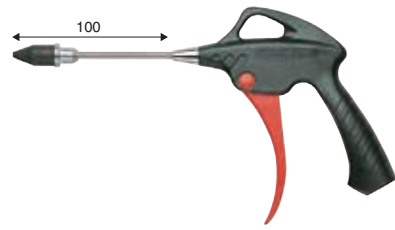

High Volume Nozzle **AD-2 0M** When more air discharge volume is required in spite of low air pressure

AD-2 0M

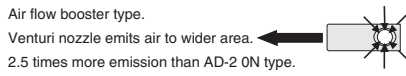

Chip Shield Long Nozzle **AD-2 100P** Plastic plate prevents dust and particles from blowing back and scattering

AD-2 100P

Ideal for blowing out dust from a narrow hole or deep place.

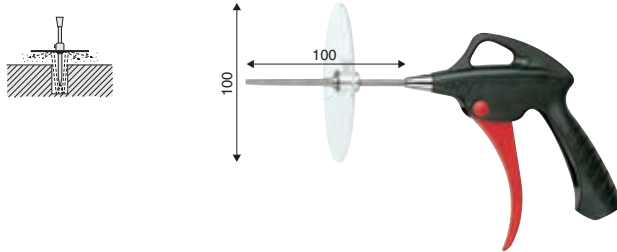

Air Screen Nozzle **AD-2 0C** Air curtain prevents dust and particles from blowing back and scattering

AD-2 0C

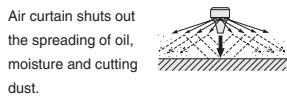



















Large lever for operating with 4 fingers. The airflow can be changed by the force of pulling the lever. Ergonomically designed handle for outstanding workability. For removal and blowing of dust, and drying, the work such as steel plate, painting, automotive maintenance, molding, metal processing, and so on.

Code No.	Model No.	Nozzle Shape	Nozzle		Air Consumption (ℓ/min)	Overall Length (mm)	Weight (g)	Outer Ctn.	Card/ Box Size (mm)	JAN (4907587)
			Length	Inner Dia. (mm)						
141116	AD-2 0R	Rubber Nozzle	0	2.1	115	155.5	123	10	232×152×30	017659
141117	AD-2 100R	Rubber Long Nozzle	100	2.1	115	227	147	10	232×182×30	017666
141118	AD-2 0M	High Volume Nozzle	0	10	185	160	126	10	232×152×30	017703
141120	AD-2 100P	Chip Shield Long Nozzle	100	2.1	135	242	157	10	232×182×30	017642
141119	AD-2 0C	Air Screen Nozzle	0	2.8	260	145	127	10	232×152×30	017710

● Working fluid: compressed air ● Max. working pressure: 0.97MPa ● Working temperature range: 0-60°C(32-140°F) ● Air inlet screw diameter: Rc 1/4 ● Working air hose ID: φ4mm and more ● Air pressure when air consumption is measured: 0.49MPa ● Blister packing ※Nozzle can not be replaced.

HAND TOOLS
INDUSTRIAL BITS
CONSTRUCTION BITS
RECIPROCATING SAW BLADES
ELECTRIC TOOLS
AIR TOOLS
AIR NIPPERS
STATIC SOLUTIONS
GASLINE ENGINE TOOLS

 Read the instruction manual before using, and follow the instructions when using.

<p>HAND TOOLS</p> <p>Hand Tools</p> 	<p>https://www.vessel.co.jp/english/support/safety/handtools.html</p> <ul style="list-style-type: none"> • Always wear protective goggles when working with the product. • Do not use the product if any abnormality such as cracks, chipping, abrasion, or deformation is found. • Make sure of the applications, size, and usage that are suitable for the product before use. • Do not use the product in place of a hammer, crowbar, or lever. • Do not use the product in which electricity is running. • Do not modify the product. 
<p>INDUSTRIAL BITS</p> <p>Industrial Bits</p> 	<p>https://www.vessel.co.jp/english/support/safety/bit.html</p> <ul style="list-style-type: none"> • Read the instruction manual of the power tool carefully before use. • Always wear protective goggles when working with the product. • Be sure to shut off the power source before mounting or replacing bits. • Do not use the product if any abnormality such as cracks, chipping, abrasion, or deformation is found. • Never attempt to operate the power tool at no-load with the product attached. • Do not use the product in which electricity is running. • Do not modify the product. 
<p>CONSTRUCTION BITS</p> <p>Construction Bits</p> 	<p>https://www.vessel.co.jp/english/support/safety/bit.html</p> <ul style="list-style-type: none"> • Read the instruction manual of the power tool carefully before use. • Always wear protective goggles when working with the product. • Be sure to shut off the power source before mounting or replacing bits. • Do not use the product if any abnormality such as cracks, chipping, abrasion, or deformation is found. • Never attempt to operate the power tool at no-load with the product attached. • Do not use the product in which electricity is running. • Do not modify the product. 
<p>RECIPROCATING SAW BLADES</p> <p>Reciprocating Saw Blades</p> 	<p>https://www.vessel.co.jp/english/support/safety/saw_blades.html</p> <ul style="list-style-type: none"> • Check the applications and capabilities of the blade. • Read the instruction manual of the power tool carefully. • Always shut off the power source when replacing blades. • Before use, make sure that the blade is not loosely mounted. • Do not overload the product as this may cause damage to the blade. • Do not touch the blade just after stopping to use because they are hot. • Wear protective goggles and gloves when using the product. • Stop using the product if any abnormality is found. 
<p>ELECTRIC TOOLS</p> <p>Electric Tools</p> 	<p>https://www.vessel.co.jp/english/support/safety/electric.html</p> <ul style="list-style-type: none"> • Always wear protective goggles when working with the product. • Be sure to shut off the power source before mounting or replacing the tip tools. • Be sure to use a tip tool for power tools. • Do not use the product if any abnormality such as cracks, chipping, abrasion, or deformation is found. • Never attempt to operate the product at no-load with a tip tool mounted on the product. • Do not use the product in which electricity is running. • Do not disassemble or modify the product. 
<p>AIR TOOLS</p> <p>Air Tools</p> 	<p>https://www.vessel.co.jp/english/support/safety/airtools.html</p> <ul style="list-style-type: none"> • Use protective items such as a helmet, safety glasses, earplugs, dust mask, safety shoes, and others, depending on the work. • When installing or replacing the tip tools, be sure to shut off the air supply source. • Be sure to use a tip tool for power tools. • Do not use the product if any abnormality such as cracks, chipping, abrasion, or deformation is found. • Never attempt to operate the product at no-load with a tip tool mounted on the product. • Do not use the product in which electricity is running. • Do not modify the product. 
<p>AIR NIPPERS</p> <p>Air Nippers</p> 	<p>https://www.vessel.co.jp/english/support/safety/airnipper.html</p> <ul style="list-style-type: none"> • Do not touch the blade. • Always wear protective goggles and earplugs when working with the product. • When installing or replacing blades or the nipper, be sure to shut off the power source. • Do not use the product if any abnormality such as cracks, chipping, abrasion, or deformation is found. • Do not use the product in which electricity is running. • The product may cause vibration. • Do not modify the product. 
<p>STATIC SOLUTIONS</p> <p>Static Solutions</p> 	<p>https://www.vessel.co.jp/english/support/safety/staticelectric.html</p> <ul style="list-style-type: none"> • Do not use the product in the environments requiring the explosion-proof measures. • Do not use the product in an atmosphere containing flammable or combustible substances. • Do not use the product in an environment subject to rapid temperature changes or where condensation occurs. • Do not use the product in a place where it is exposed to water, solvents, oil, etc. or in a humid place. • Do not use the product with the power supply standard or the air pressure other than those specified in the specifications. • Do not disassemble or modify the product. 
<p>GASOLINE ENGINE TOOLS</p> <p>Gasoline Engine Tools</p> 	<p>https://www.vessel.co.jp/english/support/safety/gasolineengine.html</p> <ul style="list-style-type: none"> • In case any crack, chip, or deformation is observed, stop using the unit immediately. • Do not use the unit or fill fuel in presence of flame or spark. • Make sure to use two cycle oil with gasoline at mixture ratio of 1:25. • The unit emit vibration, heat and exhaust fumes. • Always wear eye, head and ear protectors when using this tool. 