

Applications

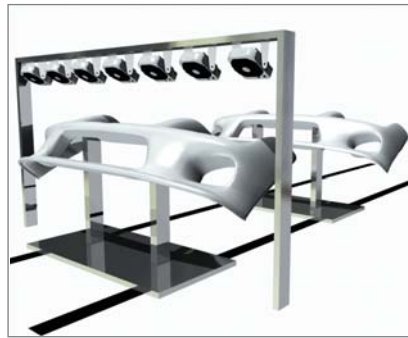

Pre-painting after bumper formation

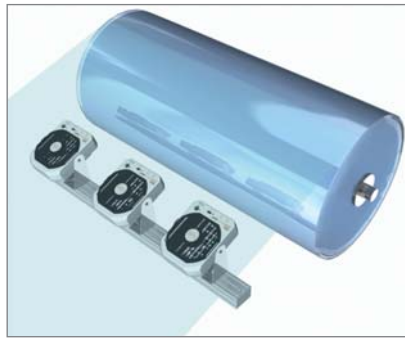

Film winding and unwinding



Preventing dust adherence on formed parts

External dimensions

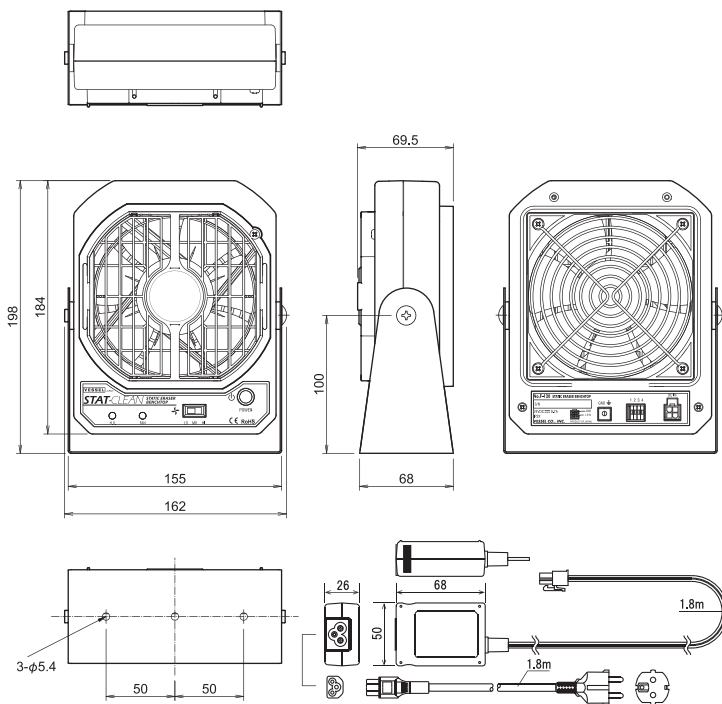

Specifications

F120R-E

Ionizing method	Piezo high-frequency AC Corona discharge method
Applied voltage	AC10kV (p-p)
Power supply and current consumption	24VDC ±5% 700mA (max.)
Dimensions	H198×W162×D70mm (with stand)
Weight	0.9 kg
Airflow	3.66m ³ /min (at max.airflow)
Noise level	61 dBA (max. and straight airflow) (measured at 1m) (measured values)
Ozone production	0.05ppm or less (measured 50mm)
Alarms	High voltage output stop (red LED), fan locked (red LED)
Protection function	Fan motor rotation monitoring function (Detecting rotation lock) High-voltage output shut down function (overload detection), Front cover safety device (circuit cut off when open)
Operating environment temperature and humidity	5~40°C 35~65%RH (with no dew condensation or freezing)
Storage environment temperature and humidity	0~60°C 35~85%RH (with no dew condensation or freezing)
Operating range	150 mm to 900 mm
Installation place	Non-hazardous place indoors
Decay time	within 1.5sec (at max.airflow, straight, measured at 300mm) (measured values)
Ion balance	within ±10V
Material	Body : Flame-retardant ABS resin Stand : Stainless steel Front cover : Flame-retardant ABS resin Electrode needles : Stainless steel
Accessories	Instruction Manual, AC adapter AD-24IT-EX

Replacement parts

Front Cover w/Electrode Needles
F-120RCH

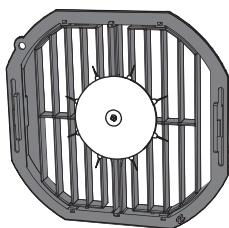

Options

Filter set
F-120FS

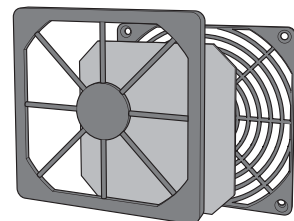

Filter
F-12EF

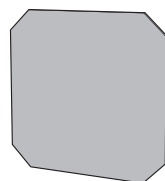

VESSEL Co., Inc.

17-25, Fukae-Kita 2-chome, Higashinari-ku, Osaka 537-0001 JAPAN
Tel : +81(0)6 6976 7778 Fax : +81(0)6 6972 9441

VESSEL EUROPE

6, avenue du 1er Mai, ZAE Les Glaises, 91120 Palaiseau FRANCE
Tel : +33(0)1 69 19 17 42 Fax : +33(0)1 69 19 42 20

E-mail : export@vessel.co.jp URL : http://www.vessel.co.jp/english/

- Product specifications, dimensions, pricing, and other information are subject to change without notice.
- Static electricity erasing capability values given in this catalog were obtained in our measurement environment. Your results may differ depending on the operating environment.

Distributed by



VESSEL

Let us think.

“Authentic ionizing performance”

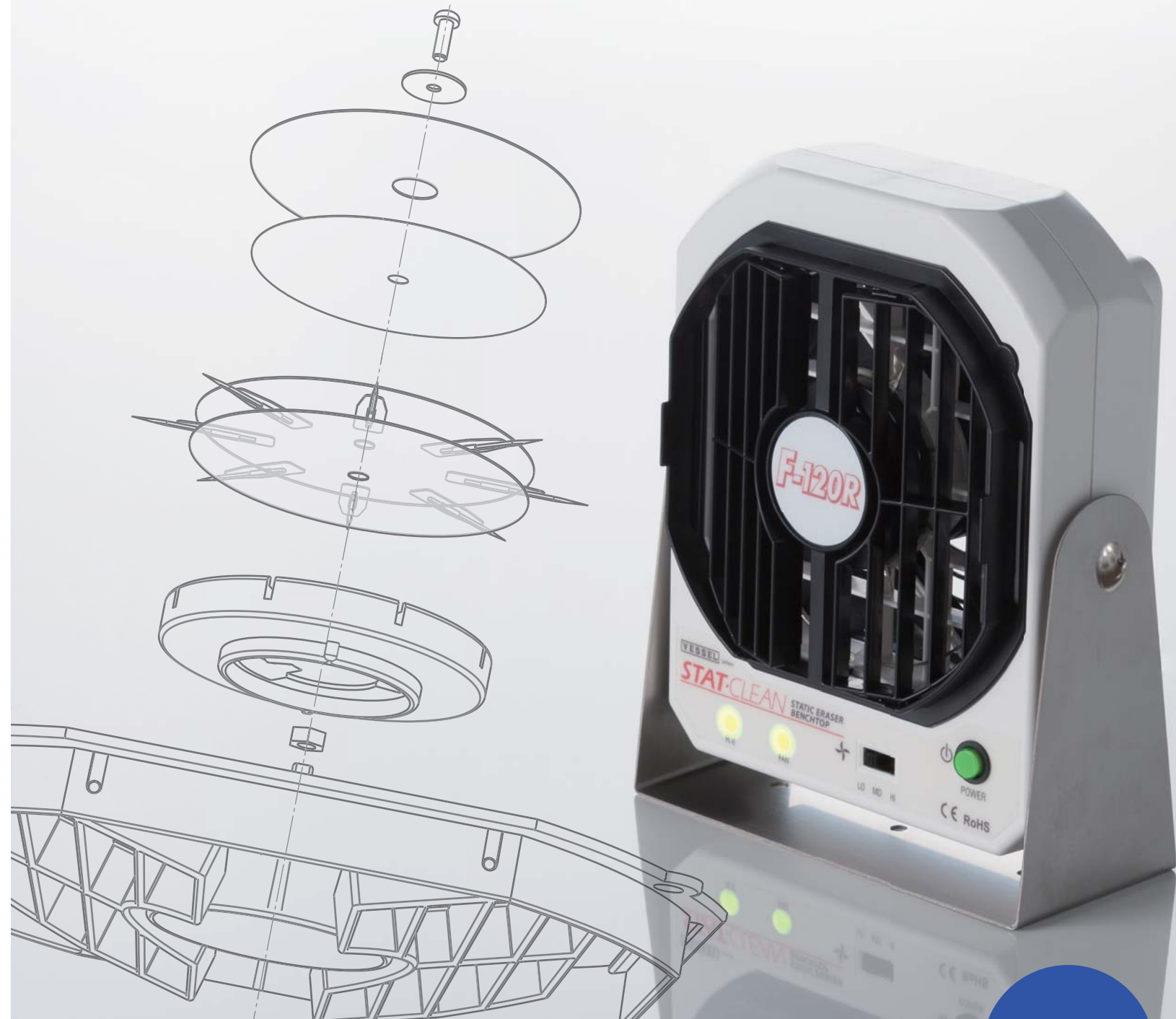

Reliable long-lasting ionizing performance
Butterfly louver for flexible setting of the ionizing area

NEW

STAT·CLEAN

Fan-type Ionizer

F120R-E

Unique capacitive-coupled electrode needles for stable and long-lasting ionizing performance

VESSEL's patented unique capacitive-coupled electrode needles enable the F120R-E to perform with the superior ion balance for long time. Highly frequent A/C piezoelectronic transformer generates ions in abundance and neutralizes charged products fastly.

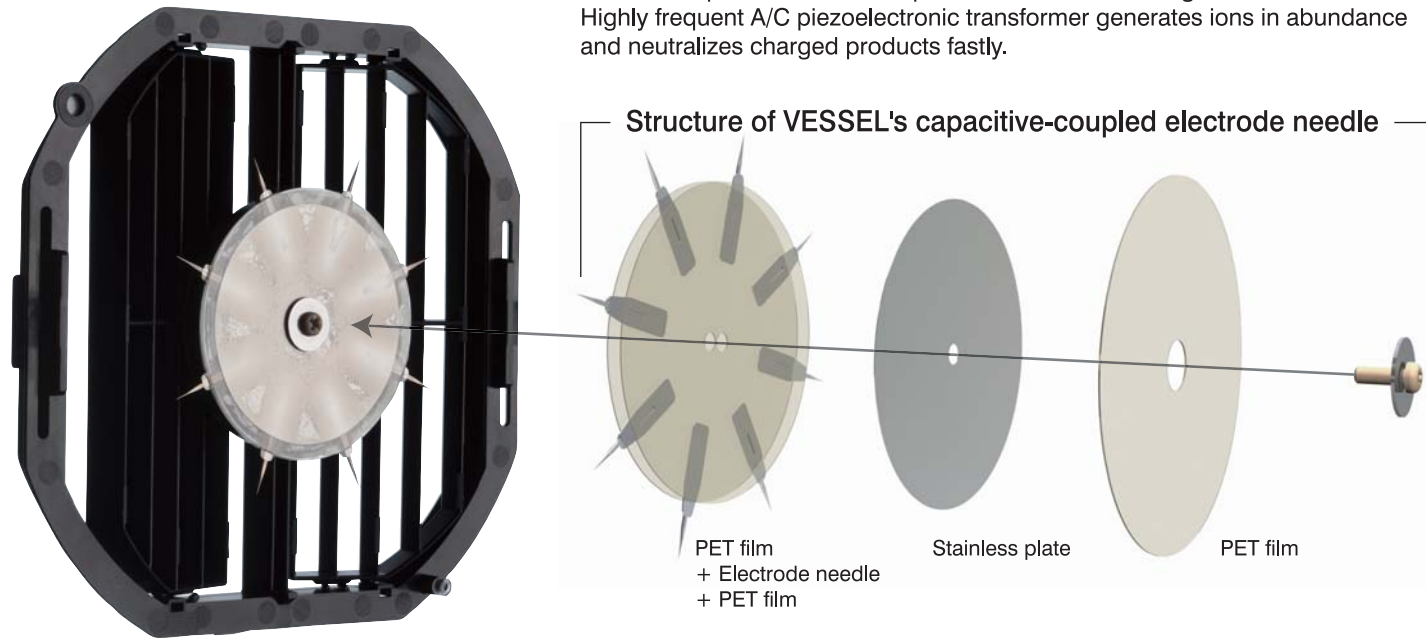

Static Erasing Performance

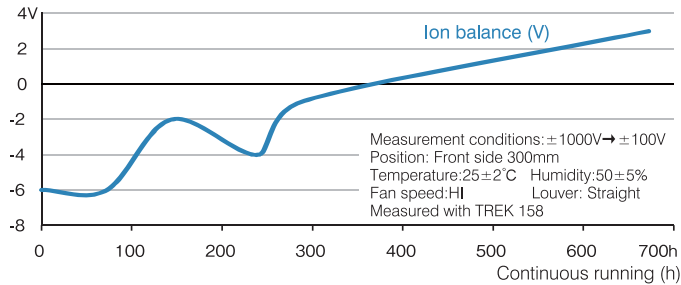
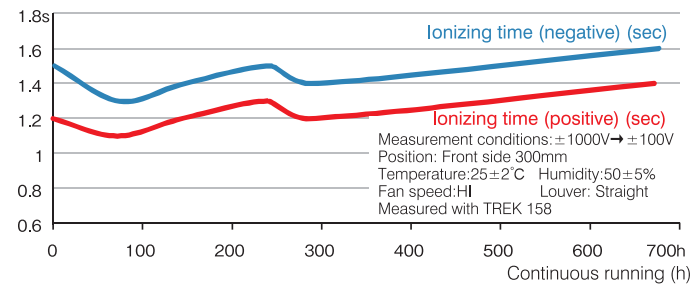

Slim and compact body

VESSEL's newly developed compact piezoelectronic transformer makes very slim and compact model available.

Clear operation status display



The new alarm function uses a 2-color LED. The lamp lights in green when the power is ON, showing the normal operation. The red light indicates various errors. Alarms can also be externally output.

Low-voltage 24VDC

The input voltage is a 24VDC low voltage which enhances safety when assembled into equipment.



RoHS/CE Standards

This ionizer is RoHS compatible and CE certified.



Less concern about reverse charging

Ion balance is within $\pm 10V$. (our measured values)
 Good for electronic parts vulnerable to static electricity.

External grounding terminal



A separate grounding terminal is available. Convenient when grounding through AC adapter is not easy.

Easy maintenance

The electrode needle unit is set into the front cover, can be easily replaced.

Butterfly louver for flexible setting of ionizing area

Butterfly Louver

Straight

Keep both side of the louver on the original position ...Air flows straight.



Wide

Press outer side of the louver ...Air is dispersed.

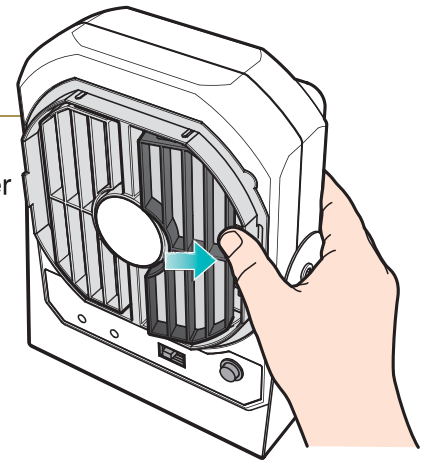

Straight



Ion balance(V)
 Decay time+(s)
 Decay time-(s)



	150mm	300mm	600mm	900mm	
-	-	-	-	-	300mm
-	-	-	-	-	150mm
-	-	-	-	-	0mm
-1V	-1V	+1V	+2V		300mm
1.0s	1.2s	2.0s	3.0s		150mm
1.0s	1.4s	2.5s	4.0s		0mm
-	-3V	+1V	+2V		150mm
-	12.6s	5.6s	6.0s		150mm
-	16.7s	7.1s	8.2s		300mm
-	-	-	-		300mm
-	-	-	-		300mm

Wide



Ion balance(V)
 Decay time+(s)
 Decay time-(s)



	150mm	300mm	600mm	900mm	
-	-	-	+3V	+2V	300mm
-	-	-	17.2s	6.9s	300mm
-	-	-	18.2s	8.8s	150mm
-3V	-2V	+1V	+1V		300mm
3.2s	2.5s	3.5s	5.7s		150mm
3.8s	3.0s	4.5s	7.6s		0mm
-2V	-2V	-1V	+2V		300mm
1.3s	2.1s	5.7s	8.9s		150mm
1.4s	2.8s	8.5s	12.4s		0mm
-3V	-3V	-1V	+1V		150mm
2.3s	2.2s	3.4s	5.5s		150mm
2.2s	2.5s	4.1s	6.8s		300mm
-	-	+1V	+1V		300mm
-	-	10.5s	6.2s		300mm
-	-	14.1s	8.4s		300mm

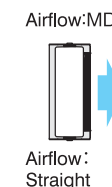

	150mm	300mm	600mm	900mm	
-	-	-	-	-	300mm
-	-	-	-	-	150mm
-	-	-	-	-	0mm
+2V	+1V	+2V	+1V		300mm
1.3s	1.6s	2.4s	3.8s		150mm
1.3s	1.8s	3.1s	5.0s		0mm
-	+1V	+2V	+2V		150mm
-	17.3s	6.9s	7.5s		150mm
-	25.0s	8.4s	9.5s		300mm
-	-	-	-		300mm
-	-	-	-		300mm

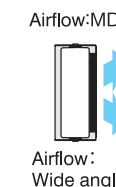

	150mm	300mm	600mm	900mm	
-	-	-	+1V	+1V	300mm
-	-	-	7.8s	9.1s	300mm
-	-	-	9.7s	12.4s	150mm
-3V	-3V	+0s	+1V		300mm
3.6s	2.9s	4.0s	6.7s		150mm
4.0s	3.3s	5.1s	8.8s		0mm
-2V	-2V	+1V	+2V		300mm
1.4s	2.5s	6.3s	10.9s		150mm
1.5s	2.8s	9.9s	14.1s		0mm
-3V	-1V	+1V	+1V		150mm
2.4s	2.7s	3.8s	6.1s		150mm
2.4s	3.0s	4.7s	8.4s		300mm
-	-	-1V	+1V		300mm
-	-	10.1s	7.1s		300mm
-	-	13.2s	9.5s		300mm



	150mm	300mm	600mm	900mm	
-	-	-	-	-	300mm
-	-	-	-	-	150mm
-	-	-	-	-	0mm
-1V	+1V	-1V	+1V		300mm
1.6s	1.9s	2.8s	4.4s		150mm
1.5s	2.2s	3.6s	5.9s		0mm
-	-	+2V	+1V		150mm
-	-	9.3s	8.7s		150mm
-	-	10.7s	12.4s		300mm
-	-	-	-		300mm
-	-	-	-		300mm



	150mm	300mm	600mm	900mm	
-	-	-	+2	+1	300mm
-	-	-	8.6s	11.7s	300mm
-	-	-	11.2s	14.3s	150mm
-2V	-2V	+2V	+2V		300mm
4.2s	3.6s	4.9s	7.7s		150mm
4.5s	4.0s	6.0s	10.0s		0mm
-2V	-1V	+1V	+1V		300mm
3.7s	3.1s	4.6s	7.5s		150mm
4.0s	3.5s	5.7s	9.7s		0mm
-2V	-1V	+1V	+1V		150mm
3.7s	3.1s	4.6s	7.5s		150mm
4.0s	3.5s	5.7s	9.7s		300mm
-	-	+1V	+1V		300mm
-	-	8.7s	10.7s		300mm
-	-	10.4s	15.2s		300mm

Measurement conditions: Temperature: 25.0°C, Humidity: 50.0%, Measured with TREK158 (20pF 150x150mm)